



Title	<i>Reference Design Report for 6.6 W Non-Isolated Buck Converter Using LinkSwitch™-TN2 LNK3207D</i>
Specification	85 VAC – 265 VAC Input; 12 V, 550 mA Output
Application	Small Appliance
Author	Applications Engineering Department
Document Number	RDR-912
Date	October 8, 2020
Revision	1.1

Summary and Features

- 725 V maximum drain voltage
- Highly integrated solution
- Lowest possible component count
- No optocoupler required for regulation
- Thermal overload protection with automatic recovery
- >80% efficiency at full load
- <±5% load regulation

PATENT INFORMATION

The products and applications illustrated herein (including transformer construction and circuits external to the products) may be covered by one or more U.S. and foreign patents, or potentially by pending U.S. and foreign patent applications assigned to Power Integrations. A complete list of Power Integrations' patents may be found at www.power.com. Power Integrations grants its customers a license under certain patent rights as set forth at <https://www.power.com/company/intellectual-property-licensing/>.

Power Integrations

5245 Hellyer Avenue, San Jose, CA 95138 USA.
Tel: +1 408 414 9200 Fax: +1 408 414 9201
www.power.com

Table of Contents

1	Introduction	4
2	Power Supply Specification	5
3	Schematic	6
4	Circuit Description	7
4.1	Input EMI Filtering	7
4.2	LinkSwitch-TN2	7
4.3	Output Rectification	7
4.4	Output Feedback	7
4.5	Optional Components.....	8
5	PCB Layout	9
6	Bill of Materials	10
6.1	Main BOM	10
6.2	Miscellaneous Parts.....	10
7	Design Spreadsheet.....	11
8	Performance Data	13
8.1	Efficiency vs. Line	13
8.2	Efficiency vs. Load	14
8.3	Average Efficiency	15
8.3.1	85 VAC / 60 Hz	15
8.3.2	115 VAC / 60 Hz	15
8.3.3	230 VAC / 50 Hz	15
8.3.4	265 VAC / 50 Hz	15
8.4	Standby Mode Efficiency	16
8.4.1	0.2 W Input Power	17
8.4.2	0.3 W Input Power	17
8.4.3	0.5 W Input Power	17
8.4.4	1.0 W Input Power	17
8.5	No-Load Input Power	18
8.6	Load Regulation	19
8.7	Line Regulation at Full Load	20
9	Thermal Performance	21
9.1	Ambient Thermal Performance	21
9.2	50 °C Thermal Performance	22
10	Waveforms	24
10.1	Switching Waveforms.....	24
10.1.1	LNK3207D V_{DS} and I_{DS} Waveforms Normal Operation	24
10.1.2	LNK3207D Drain Voltage and Current Waveforms During Start-Up	26
10.1.3	Drain Current and Output Waveform During Output Short	28
10.1.4	Freewheeling Diode Waveforms	29
10.1.5	Freewheeling Diode Waveforms During Start-Up.....	31
10.1.6	Output Voltage and Current Waveforms During Start-Up (CC mode)	33
10.1.7	Output Voltage and Current Waveforms During Start-Up (CR mode)	34
10.1.8	Output Voltage and Current Waveforms During Start-Up (No-Load)	35



10.2	Output Ripple Measurements.....	36
10.2.1	Ripple Measurement Technique	36
10.2.2	Measurement Results	37
10.2.3	Ripple Voltage Waveforms.....	38
10.2.4	Transient Response.....	43
11	Conducted EMI	45
11.1	550 mA Resistive Load, Floating Output (QPK / AV)	45
11.1.1	115 VAC.....	45
11.1.2	230 VAC.....	46
12	Lightning Surge	47
12.1	Differential Mode Test.....	47
12.1.1	1000 V 90° Differential Mode Surge	47
12.1.2	-1000 V 270° Differential Mode Surge	48
13	Revision History	49

Important Note:

Although this board is designed to satisfy safety isolation requirements, the engineering prototype has not been agency approved. Therefore, all testing should be performed using an isolation transformer to provide the AC input to the prototype board.

1 Introduction

This document is an engineering prototype report describing a non-isolated 12 V, 550 mA power supply utilizing a LNK3207D/G from Power Integrations. The document contains the power supply specification, schematic, bill-of-materials, printed circuit layout, and performance data.



Figure 1– Populated Circuit Board Photograph, Top.

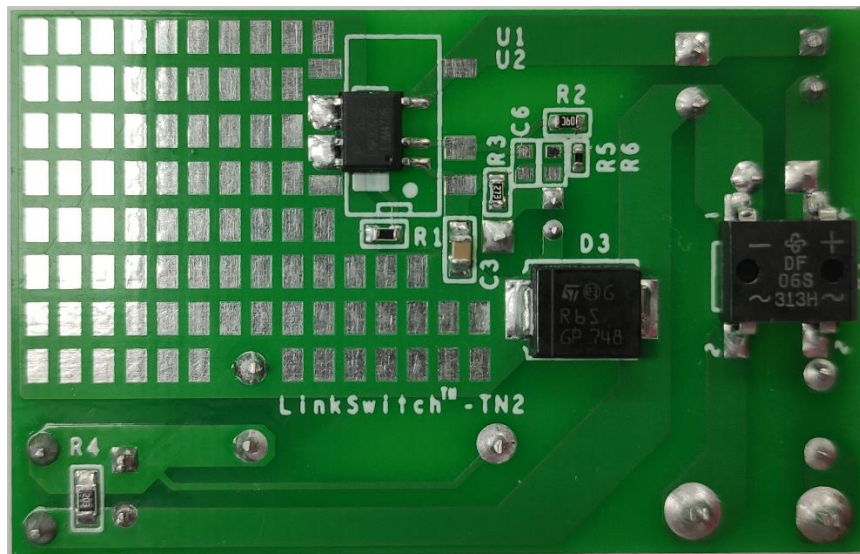

Figure 2 – Populated Circuit Board Photograph, Bottom.

2 Power Supply Specification

The table below represents the minimum acceptable performance of the design. Actual performance is listed in the results section.

Description	Symbol	Min	Typ	Max	Units	Comment
Input						
Voltage	V_{IN}	85		265	VAC	2 Wire – no P.E.
Frequency	f_{LINE}	47	50/60	64	Hz	
No-load Input Power (230 VAC)				<40	mW	
Output						
Output Voltage	V_{OUT}		12		V	±5%. 20 MHz Bandwidth.
Output Ripple Voltage	V_{RIPPLE}			120	mV	
Output Current	I_{OUT}		550		A	System Load upon Insertion.
Min. Output Current	$I_{OUT,MIN}$		27.5		mA	
Total Output Power						
Continuous Output Power	P_{OUT}		6.6		W	
Efficiency						
Full Load (Nominal)	η	80			%	Measured at the End of PCB. 25 °C.
Ave Efficiency (Nominal)		81			%	
Environmental						
Conducted EMI		Meets CISPR22B / EN55022B				
Line Surge Differential Mode (L1-L2)			1		kV	1.2/50 μ s surge, IEC 61000-4-5, Series Impedance: Differential Mode: 2 Ω .
Ambient Temperature	T_{AMB}	0		50	°C	Free Convection, Sea Level.

3 Schematic

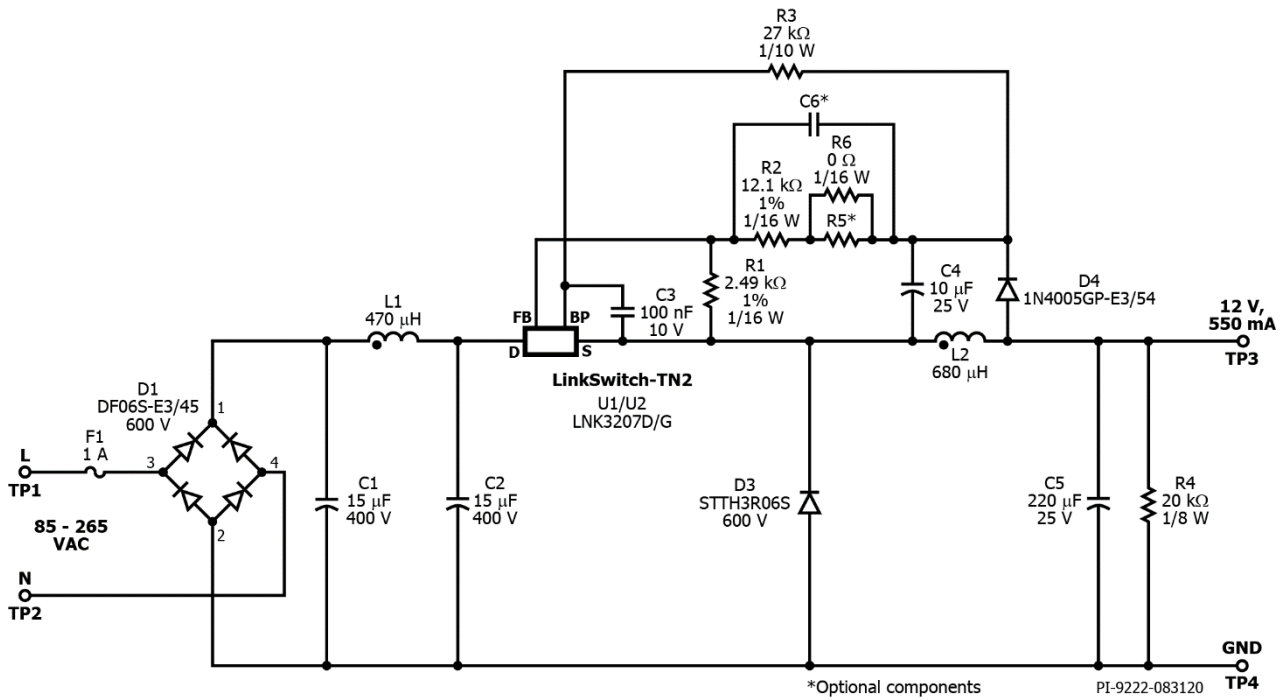

Figure 3 – Schematic.

Note:

1. U1 can be implemented as LNK3207D or U2 for LNK3207G.
2. R5 and R6 can be replaced if a higher output voltage is desired.
3. C6 is an optional feedforward capacitor which may be required on some designs.

4 Circuit Description

The schematic in Figure 3 shows an implementation of a buck converter using LNK3207D/G. The circuit provides a non-isolated 12 V, 550 mA continuous output.

4.1 *Input EMI Filtering*

The input stage is comprised of fuse F1, bridge diode D1, and an EMI suppression circuit in a pi filter configuration with C1, inductor L1, and C2.

4.2 *LinkSwitch-TN2*

The LinkSwitch-TN2 combines a high-voltage power MOSFET and the power supply controller into a low cost monolithic IC.

When AC is first applied, an internal current source connected to the DRAIN (D) pin charges C3 to power the controller inside the IC. When the output voltage is established, the device controller will now be powered from the output via a current limiting resistor R3 to minimize losses.

The control scheme used is similar to the ON/OFF control used in TinySwitch™. LinkSwitch-TN2 family of controllers work on the principle of ON-OFF control in which output regulation is achieved by skipping cycles in response to a signal applied to the FEEDBACK (FB) pin. Current into the FB pin greater than 49 μ A will inhibit the switching of the internal MOSFET, while current below this allows switching cycles to occur. During full load operation, only a few switching cycles will be skipped (disabled), which results in a high effective switching frequency. As the load is reduced, some switching cycles are skipped reducing the effective switching frequency.

4.3 *Output Rectification*

When the internal MOSFET is on, current ramps through L2 until the internal current limit is reached. This then turns off the internal MOSFET and allows the inductor current to freewheel via diode D3 for the remainder of the switching cycle. For this design, an ultrafast diode (t_{RR} of 35 ns) is selected for D3 due to continuous operation at full load. Capacitor C5 should be selected to have an adequate ripple current rating (low ESR type).

4.4 *Output Feedback*

During the power MOSFET off-time, capacitor C4 is charged to the output voltage via D4. The voltage developed across C4 tracks the output voltage. This voltage is used to provide feedback to the IC via the resistor divider formed by resistors R1 and R2. The values of R1 and R2 are selected such that at the nominal output voltage, the voltage on the FB pin is 2 V. The FEEDBACK (FB) pin is then sampled by the controller inside U1 during each switching cycle.

4.5 ***Optional Components***

Other output voltages are also possible simply by changing the values of either R2, R5, and R6. Rarely due to layout constraints, some designs may also require a feedforward capacitor, C6, for a better response. In these cases, capacitance values between 1 nF and 10 nF are recommended.



5 PCB Layout

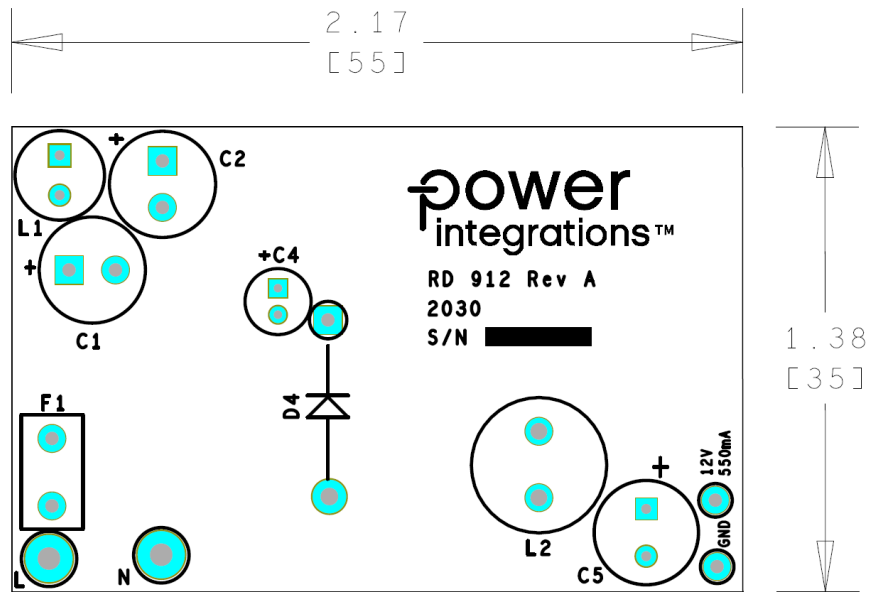

Figure 4 – Printed Circuit Layout, Top (2.17" [55 mm] L x 1.38" [35 mm] W).

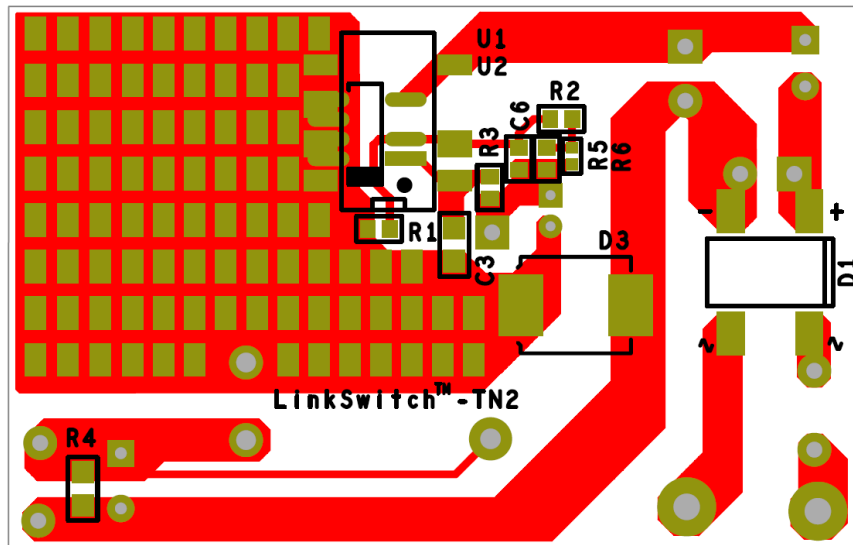

Figure 5 – Printed Circuit Layout, Bottom.

6 Bill of Materials

6.1 Main BOM

Item	Qty	Ref Des	Description	Mfg Part Number	Mfg
1	2	C1 C2	15 μ F, 400 V, 20%, Electrolytic, (8 x 16)	ERK2GM150F16OTO 400AX15MEFC8X20	Aishi Rubycon
2	1	C3	100 nF, 10 V, Ceramic, X7R, 0805	CC0805KRX7R9BB104	Yageo
3	1	C4	10 μ F, 25 V, Electrolytic, Gen Purpose, (5 x 6)	UMT1E100MDD1TP	Nichicon
4	1	C5	220 μ F, 25 V, Electrolytic, Very Low ESR, 72 m Ω , (8 x 11.5)	EKZE250ELL221MHB5D	Nippon Chemi-Con
5	1	D1	600 V, 1 A, Bridge Rectifier, SMD, DFS	DF06S-E3/45	Vishay
6	1	D3	600 V, 3 A, SMC, DO-214AB	STTH3R06S	ST Micro
7	1	D4	600V, 1A, Rectifier, Glass Passivated, 2us, DO-41	1N4005GP-E3/54	Vishay
8	1	L1	470 μ H, 0.25 A, 7.87 x 9.27 mm	RL-5480-2-470	Renco
9	1	L2	680 μ H, 0.9 A, 10%	7447480681	Würth
10	1	R1	RES, 2.49 k Ω , 1%, 1/16 W, Thick Film, 0603	ERJ-3EKF2491V	Panasonic
11	1	R2	RES, 12.1 k Ω , 1%, 1/16 W, Thick Film, 0603	ERJ-3EKF1212V	Panasonic
12	1	R3	RES, 27 k Ω , 5%, 1/10 W, Thick Film, 0603	ERJ-3GEYJ273V	Panasonic
13	1	R4	RES, 20 k Ω , 5%, 1/8 W, Thick Film, 0805	ERJ-6GEYJ203V	Panasonic
14	1	R6	RES, 0 Ω , 5%, 1/16 W, Thick Film, 0402	CRCW04020000Z0ED	Panasonic
15	1	F1	1 A, 250 V, Slow, Long Time Lag, RST 1	RST 1	Belfuse
16	1	U1/U2	LinkSwitch-TN2 IC	LNK3207D/G	Power Integrations

6.2 Miscellaneous Parts

Item	Qty	Ref Des	Description	Mfg Part Number	Mfg
1	1	L	Test Point, WHT, THRU-HOLE MOUNT	5012	Keystone
2	1	N	Test Point, BLK, THRU-HOLE MOUNT	5011	Keystone
3	1	12V	Test Point, RED, Miniature THRU-HOLE MOUNT	5000	Keystone
4	1	GND	Test Point, BLK, Miniature THRU-HOLE MOUNT	5001	Keystone

7 Design Spreadsheet

ACDC_LinkSwitchTN2-Buck_052120; Rev.1.3; Copyright Power Integrations 2020	INPUT	INFO	OUTPUT	UNIT	ACDC_LinkSwitchTN2 Buck
APPLICATION VARIABLES					
LINE VOLTAGE RANGE			Universal		AC line voltage range
VACMIN			85.00	V	Minimum AC line voltage
VACTYP			115.00	V	Typical AC line voltage
VACMAX			265.00	V	Maximum AC line voltage
fL			60.00	Hz	AC mains frequency
LINE RECTIFICATION TYPE	F		F		Select 'F'ull wave rectification or 'H'alf wave rectification
VOUT			12.00	V	Output voltage
IOUT	0.550	Info	0.550	A	Device operation is too continuous, verify power delivery on the bench or select a larger device
EFFICIENCY_ESTIMATED			0.80		Efficiency estimate at output terminals
EFFICIENCY_CALCULATED			0.75		Calculated efficiency based on real components and operating point
POUT			6.60	W	Continuous Output Power
CIN	30.00		30.00	uF	Input capacitor
VMIN			104.4	V	Valley of the rectified input voltage
VMAX			374.8	V	Peak of the rectified maximum input AC voltage
T_AMBIENT			50	degC	Operating ambient temperature in degrees celcius
INPUT STAGE RESISTANCE	0		0	Ohms	Input stage resistance in ohms (includes fuse, thermistor, filtering components)
PLOSS_INPUTSTAGE			0	W	Input stage losses estimate
CONTROLLER SELECTION					
OPERATION MODE			MCM		Mostly continuous mode of operation
CURRENT LIMIT MODE	STD		STD		Choose 'RED' for reduced current limit or 'STD' for standard current limit
PACKAGE	DIP-8C		DIP-8C		Select the device package
DEVICE SERIES	Auto		LNK32X7		Generic LinkSwitch-TN2 device
DEVICE CODE			LNK3207		Required LinkSwitch-TN2 device
ILIMITMIN			0.725	A	Minimum current limit of the device
ILIMITTYP			0.780	A	Typical current limit of the device
ILIMITMAX			0.835	A	Maximum current limit of the device
RDSON			12.90	ohms	MOSFET's on-time drain to source resistance at 100degC
FSMIN			62000	Hz	Minimum switching frequency
FSTYP			66000	Hz	Typical switching frequency
FSMAX			70000	Hz	Maximum switching frequency
VDSON			2.00	V	MOSFET on-time drain to source voltage estimate
SWITCH PARAMETERS					
DUTY			0.12		Maximum duty cycle
TIME_ON			1.988	us	MOSFET conduction time at the minimum line voltage
TIME_ON_MIN			1.350	us	MOSFET conduction time at the maximum line voltage
KP_TRANSIENT		Info	0.114		Transient KP less than 0.2 may lead to a leading edge SOA trigger
IRMS_MOSFET			0.196	A	MOSFET RMS current
PLOSS_MOSFET			0.970	W	Primary MOSFET loss estimate
BUCK INDUCTOR PARAMETERS					
INDUCTANCE_MIN			612	uH	Minimum design inductance required for power delivery
INDUCTANCE_TYP			680	uH	Typical design inductance required for power delivery
INDUCTANCE_MAX			748	uH	Maximum design inductance required for power delivery
TOLERANCE_INDUCTANCE			10	%	Tolerance of the design inductance
DC RESISTANCE OF INDUCTOR			2.0	ohms	DC resistance of the buck inductor
FACTOR_LOSS			0.900		Factor that accounts for "off-state" power loss to be supplied by inductor
IRMS_INDUCTOR			0.559	A	Inductor RMS current
PLOSS_INDUCTOR			0.625	W	Inductor losses
FREEWHEELING DIODE PARAMETERS					

VF_FREEWHEELING			0.70	V	Forward voltage drop of the freewheeling diode
PIV			468	V	Peak inverse voltage of the freewheeling diode
IRMS_DIODE			0.524	A	Diode RMS current
TRR			30	ns	Required reverse recovery time of the selected diode
PLOSS_DIODE			0.609	W	Freewheeling diode losses
RECOMMENDED DIODE			BYV26C	W	Recommended freewheeling diode
BIAS/FEEDBACK PARAMETERS					
VF_BIAS			0.70	V	Forward voltage drop of the bias diode
RBIAS			2490	Ohms	Bias resistor
CBP			0.1	uF	BP pin capacitor
RFB			11800	Ohms	Feedback resistor
CFB			10	uF	Feedback capacitor
C_SOFTSTART			1-10	uF	If the output voltage is greater than 12 V or total output and system capacitance is greater than 100 uF, a soft start capacitor between 1uF and 10 uF is recommended
PLOSS_FEEDBACK			0.010	W	Feedback section losses
OUTPUT CAPACITOR					
OUTPUT VOLTAGE RIPPLE			240	mV	Desired output voltage ripple
IRIPPLE_COUT			0.350	A	Output capacitor ripple current
ESR_COUT			686	mOhms	Maximum ESR of the output capacitor



8 Performance Data

All measurements performed at room temperature.

8.1 Efficiency vs. Line

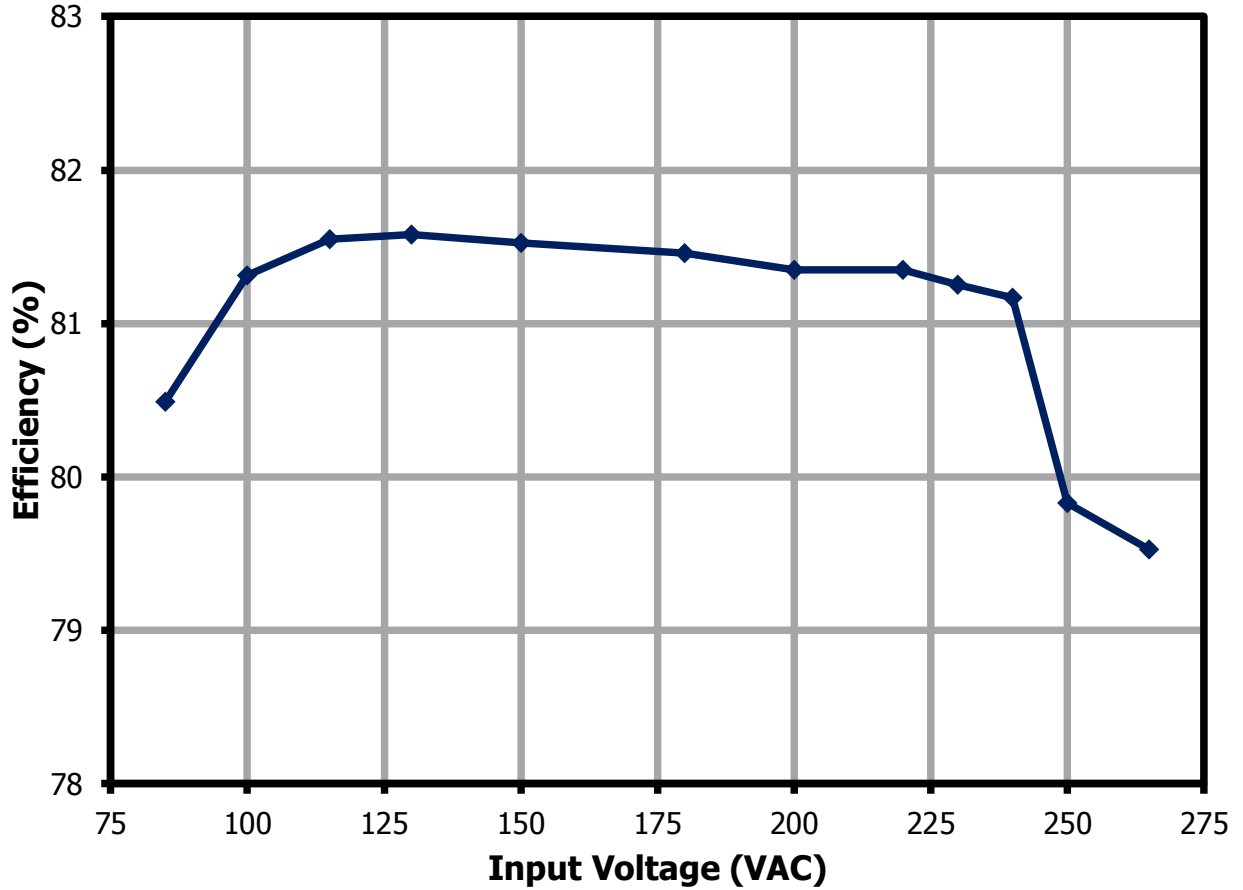

Figure 6 – Full Load (550 mA) Efficiency vs. Line Voltage, Room Temperature.



8.2 Efficiency vs. Load

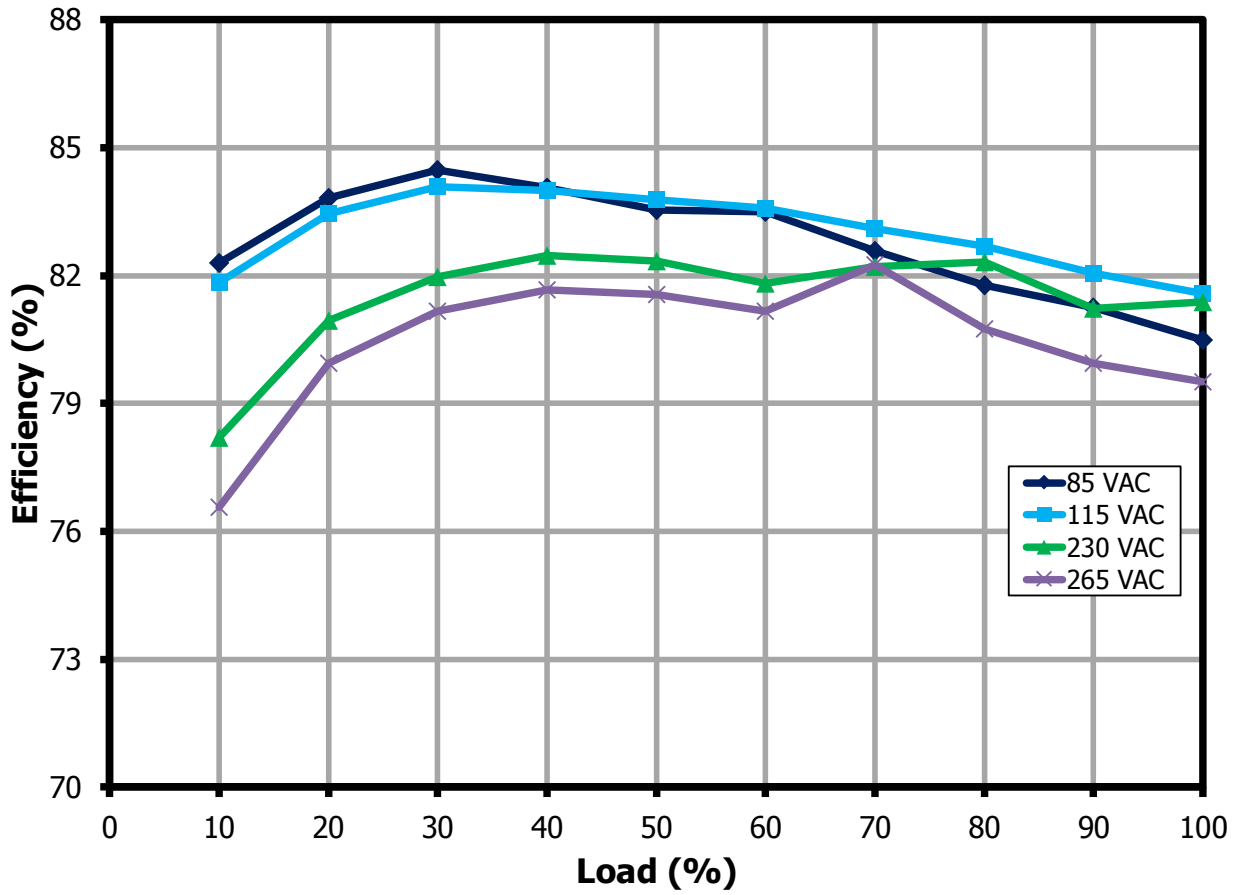

Figure 7 – Efficiency vs. Load, Room Temperature.

8.3 Average Efficiency

8.3.1 85 VAC / 60 Hz

Load (A)	V _{IN} (V _{RMS})	I _{IN} (mA _{RMS})	P _{IN} (W)	V _{OUT} at PCB (V _{DC})	I _{OUT} (mA _{DC})	P _{OUT} (W)	Efficiency at PCB (%)
100%	85	188.08	8.21	12.00	550.20	6.60	80.48
75%	85	147.30	6.02	12.03	412.78	4.97	82.47
50%	85	105.30	3.98	12.07	275.34	3.32	83.54
25%	85	61.58	1.99	12.13	137.79	1.67	84.17
						Average	82.67

8.3.2 115 VAC / 60 Hz

Load (A)	V _{IN} (V _{RMS})	I _{IN} (mA _{RMS})	P _{IN} (W)	V _{OUT} at PCB (V _{DC})	I _{OUT} (mA _{DC})	P _{OUT} (W)	Efficiency at PCB (%)
100%	115	156.67	8.1	12.00	550.19	6.60	81.58
75%	115	123.73	5.99	12.03	412.73	4.96	83.11
50%	115	88.62	3.96	12.06	275.30	3.32	83.78
25%	115	51.82	1.99	12.13	137.81	1.67	83.89
						Average	83.09

8.3.3 230 VAC / 50 Hz

Load (A)	V _{IN} (V _{RMS})	I _{IN} (mA _{RMS})	P _{IN} (W)	V _{OUT} at PCB (V _{DC})	I _{OUT} (mA _{DC})	P _{OUT} (W)	Efficiency at PCB (%)
100%	230	103.51	8.11	11.99	550.20	6.6	81.37
75%	230	81.34	6.07	12.03	412.75	4.96	81.76
50%	230	58.12	4.03	12.07	275.31	3.32	82.34
25%	230	32.16	2.05	12.11	137.80	1.67	81.53
						Average	81.75

8.3.4 265 VAC / 50 Hz

Load (A)	V _{IN} (V _{RMS})	I _{IN} (mA _{RMS})	P _{IN} (W)	V _{OUT} at PCB (V _{DC})	I _{OUT} (mA _{DC})	P _{OUT} (W)	Efficiency at PCB (%)
100%	265	98.97	8.29	11.98	550.13	6.59	79.51
75%	265	75.01	6.09	12.02	412.73	4.96	81.43
50%	265	52.88	4.07	12.06	275.29	3.32	81.56
25%	265	29.28	2.07	12.10	137.79	1.67	80.71
						Average	80.80

8.4 Standby Mode Efficiency

Test Condition: Soak at full load for 5 minutes and decrease load to standby mode for 5 minutes for each line step.

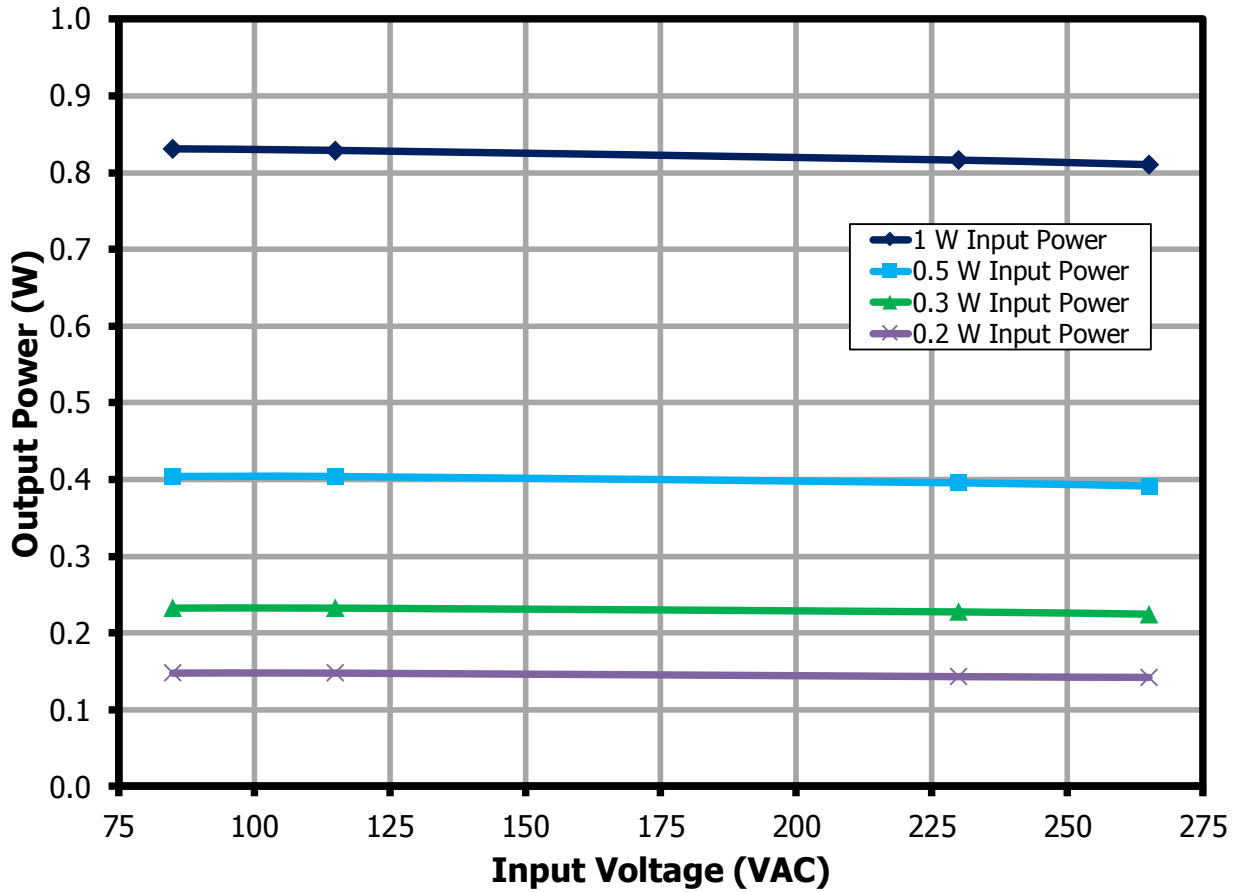

Figure 8 – Available Output Power per Input Power.

8.4.1 0.2 W Input Power

Input Measurement			Output 1 Measurement			Efficiency (%)
V _{IN} (RMS)	I _{IN} (mA)	P _{IN} (W)	V _{OUT} (V)	I _{OUT} (mA)	P _{OUT} (W)	
85	11.63	0.20	12.328	11.98	0.148	74.0
115	9.63	0.20	12.324	11.98	0.148	74.0
230	5.35	0.20	12.322	11.59	0.143	71.5
265	4.50	0.20	12.323	11.32	0.141	70.5

8.4.2 0.3 W Input Power

Input Measurement			Output 1 Measurement			Efficiency (%)
V _{IN} (RMS)	I _{IN} (mA)	P _{IN} (W)	V _{OUT} (V)	I _{OUT} (mA)	P _{OUT} (W)	
85	14.94	0.30	12.274	19.00	0.233	77.7
115	12.36	0.30	12.268	19.01	0.233	77.7
230	7.06	0.30	12.259	18.63	0.228	76.0
265	6.03	0.30	12.261	18.33	0.225	75.0

8.4.3 0.5 W Input Power

Input Measurement			Output 1 Measurement			Efficiency (%)
V _{IN} (RMS)	I _{IN} (mA)	P _{IN} (W)	V _{OUT} (V)	I _{OUT} (mA)	P _{OUT} (W)	
85	21.17	0.50	12.223	33.06	0.404	80.8
115	17.41	0.50	12.215	33.07	0.403	80.6
230	10.24	0.50	12.202	32.42	0.396	79.2
265	8.96	0.50	12.201	32.11	0.392	78.4

8.4.4 1.0 W Input Power

Input Measurement			Output 1 Measurement			Efficiency (%)
V _{IN} (RMS)	I _{IN} (mA)	P _{IN} (W)	V _{OUT} (V)	I _{OUT} (mA)	P _{OUT} (W)	
85	35.95	1.00	12.168	68.32	0.831	83.1
115	29.50	1.00	12.164	68.12	0.829	82.9
230	17.65	1.00	12.144	67.19	0.815	81.5
265	15.80	1.00	12.144	66.69	0.810	81.0

8.5 **No-Load Input Power**

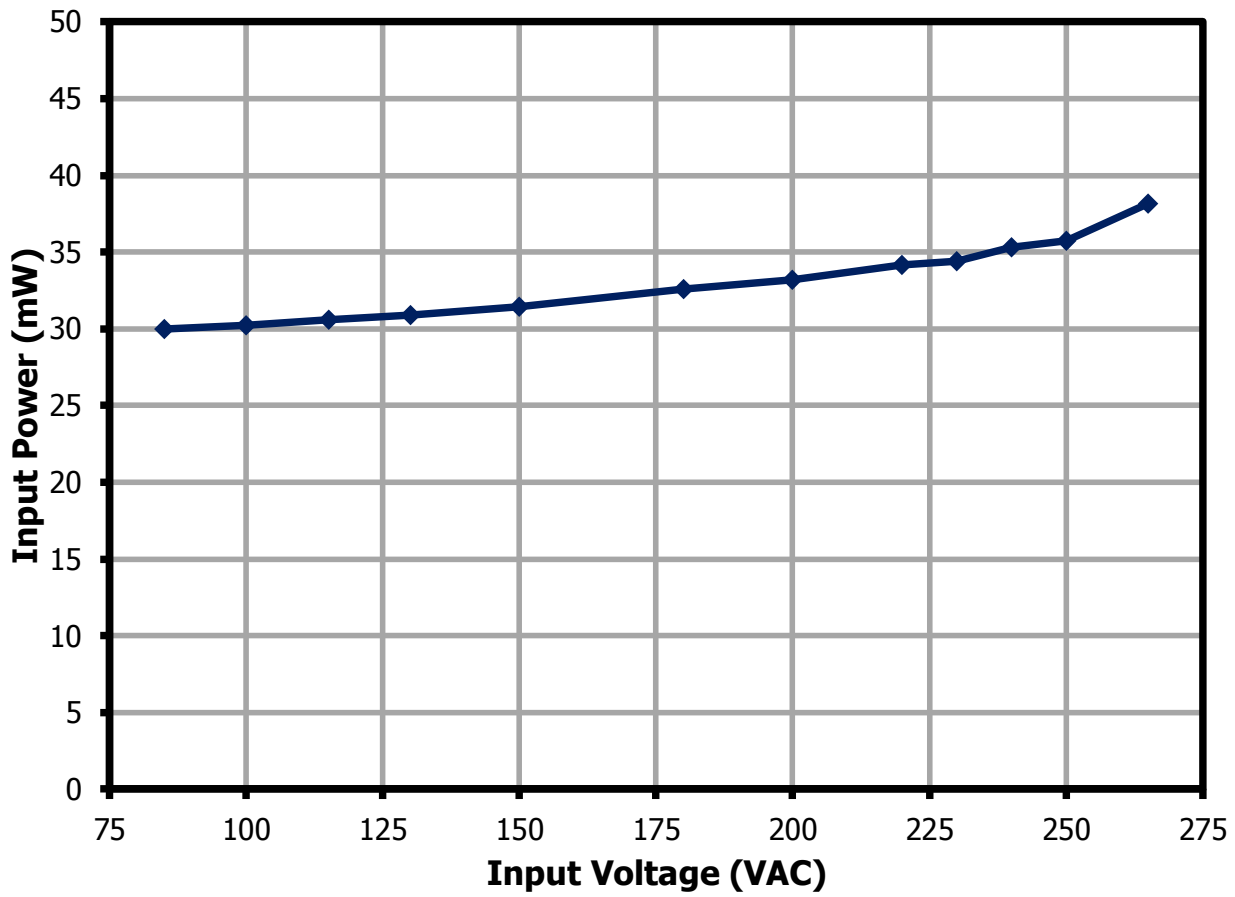

Figure 9 – No-Load Input Power vs. Input Line Voltage, Room Temperature.

8.6 Load Regulation

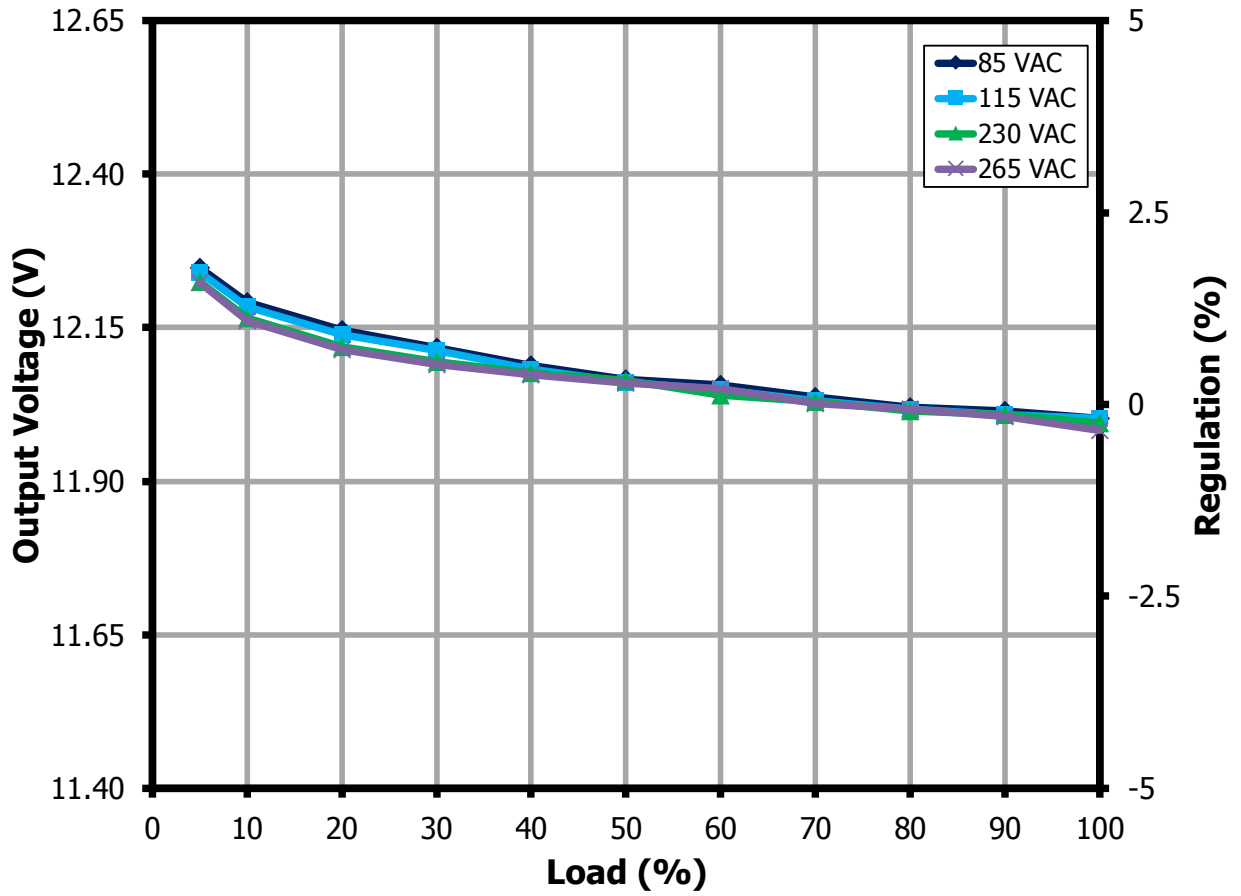

Figure 10 – Output Voltage vs. Output Current, Room Temperature.



8.7 **Line Regulation at Full Load**

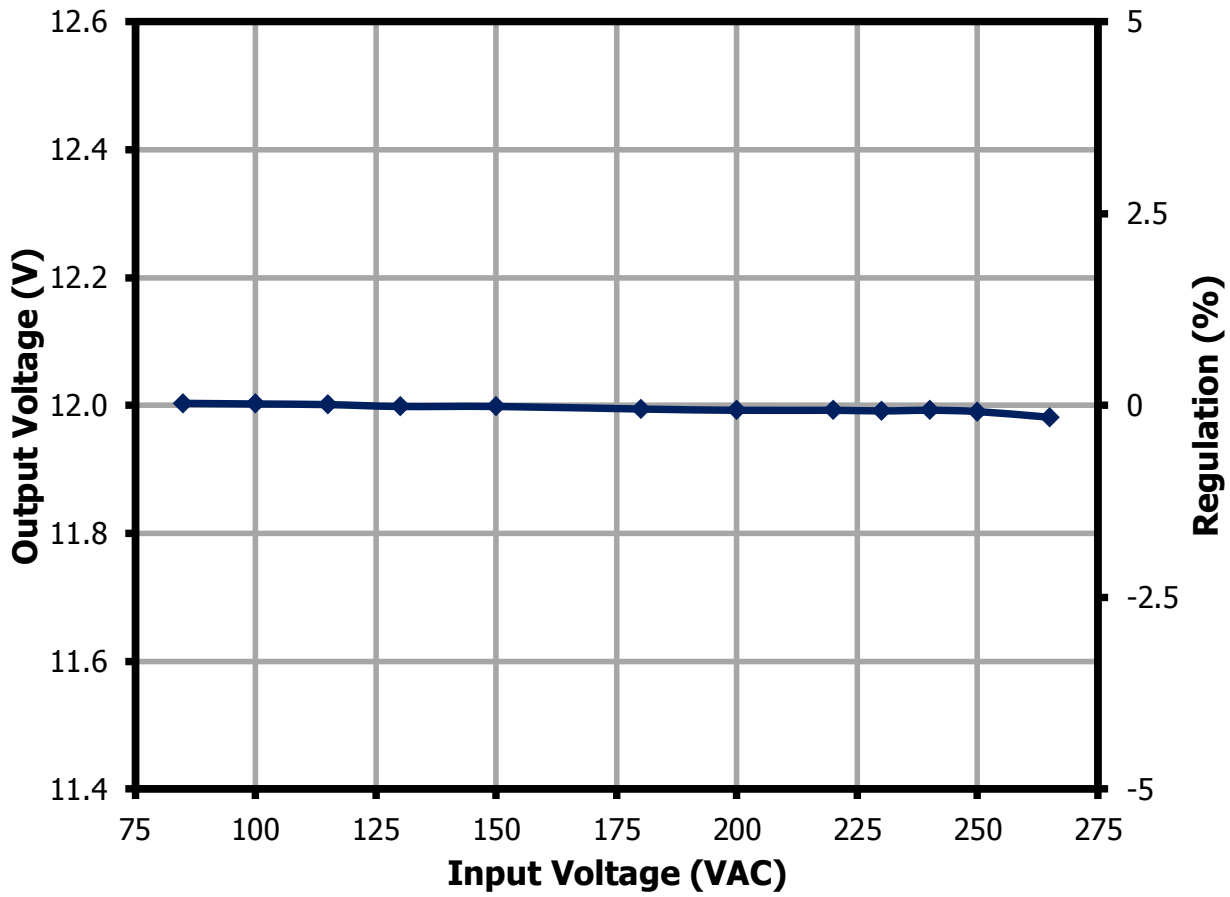

Figure 11 – Output Voltage vs. Input Voltage, Room Temperature.

9 Thermal Performance

9.1 Ambient Thermal Performance

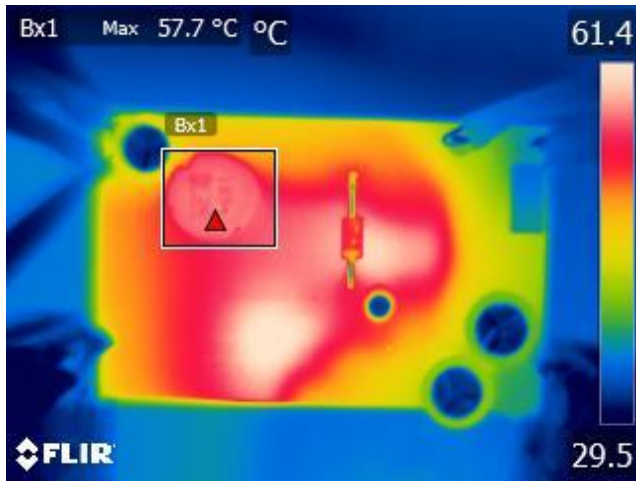

Figure 12 – Buck Choke (Bx1), 57.7 °C.
85 VAC, 550 mA Output.

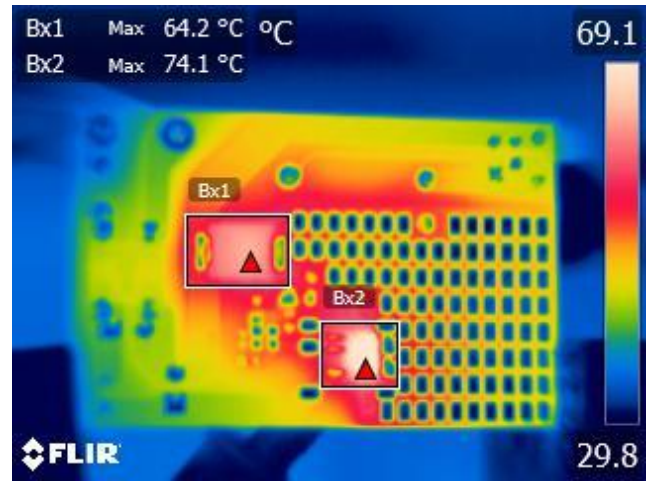

Figure 13 – Buck Diode (Bx1), 64.2 °C.
LNK3207D (Bx2), 74.1 °C.
85 VAC, 550 mA Output.

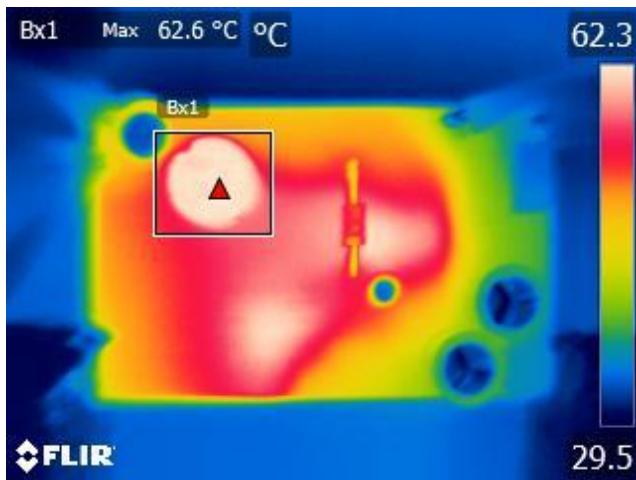

Figure 14 – Buck Choke (Bx1), 62.6 °C..
265 VAC, 550 mA Output.

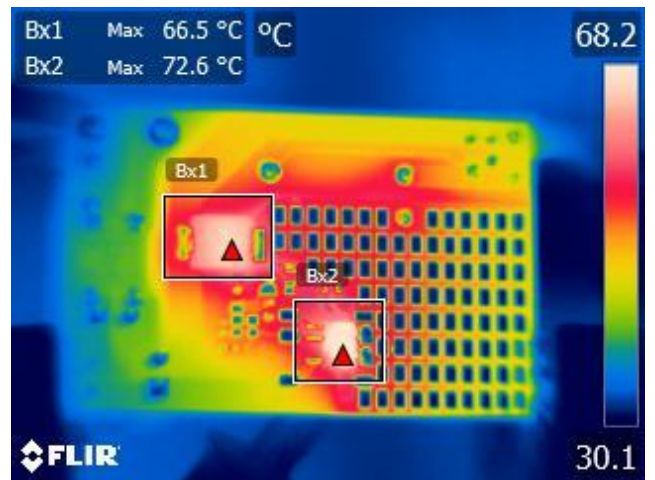

Figure 15 – Buck Diode (Bx1), 66.5 °C.
LNK3207D (Bx2), 72.6 °C.
265 VAC, 550 mA Output.

9.2 **50 °C Thermal Performance**

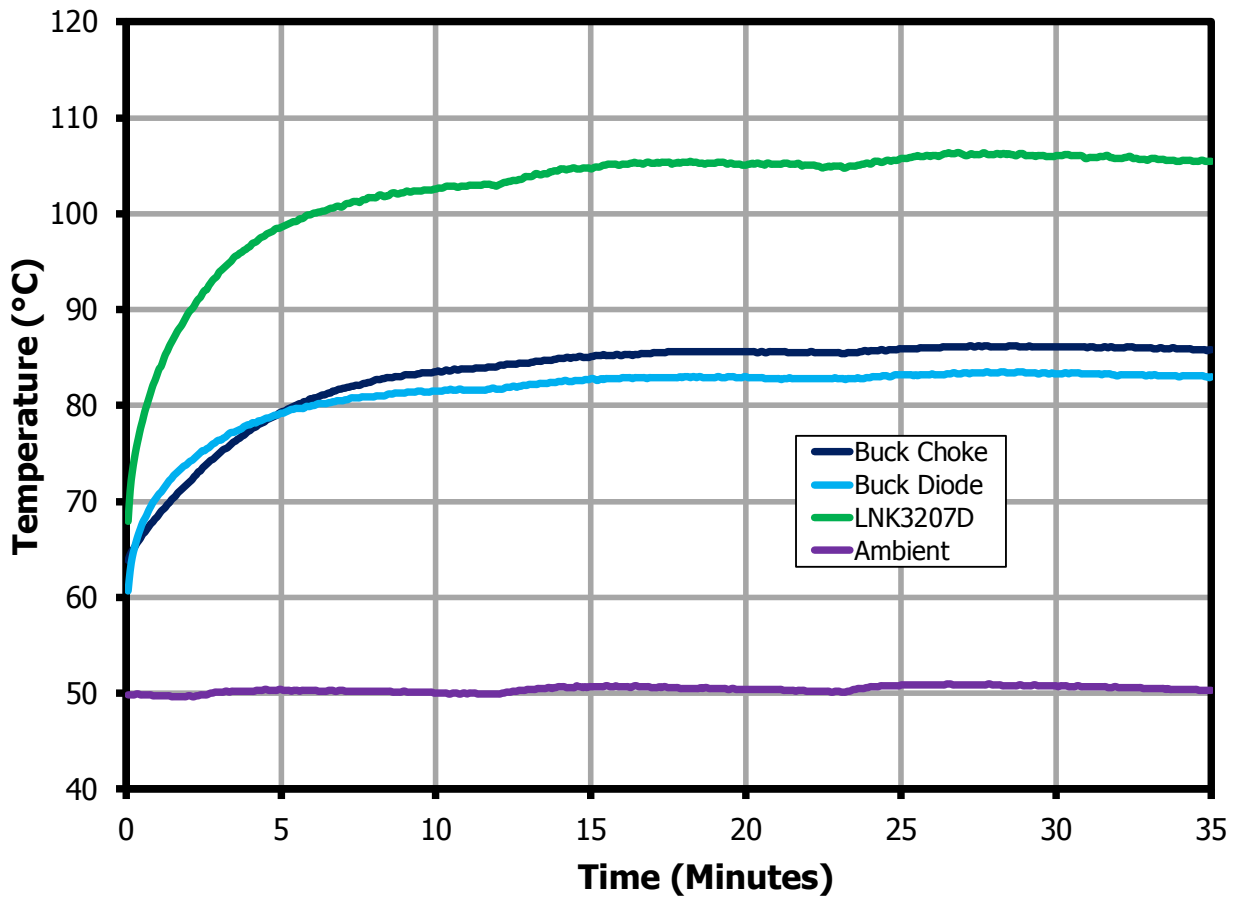

Figure 16 – 85 VAC Thermal Performance at Full Load.

Component	Temperature (°C)
Buck Choke, L2	85.8
Buck Diode, D3	83.0
LNK3207D, U1/U2	105.5
Ambient	50.3

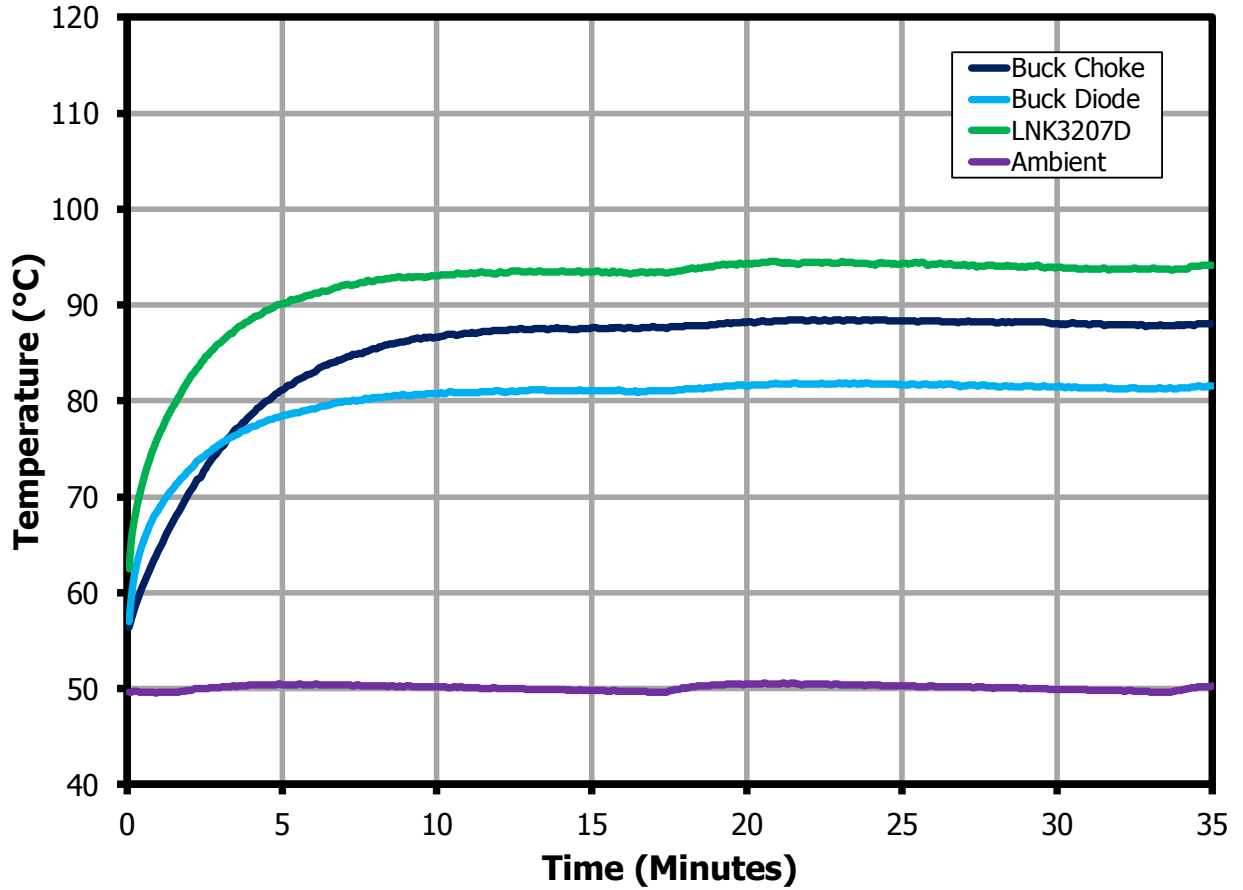

Figure 17 – 265 VAC Thermal Performance at Full Load.

Component	Temperature (°C)
Buck Choke, L2	88.0
Buck Diode, D3	81.6
LNK3207D, U1/U2	94.1
Ambient	50.3



10 Waveforms

10.1 Switching Waveforms

10.1.1 LNK3207D V_{DS} and I_{DS} Waveforms Normal Operation

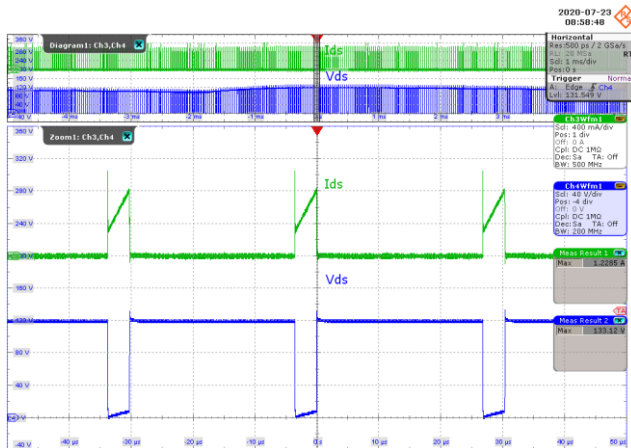

Figure 18 – Drain Voltage and Current Waveforms. 85 VAC, 550 mA Output. Upper: I_{DS} , 400 mA / div. Lower: V_{DS} , 40 V / div., 10 μ s / div. $I_{DS(MAX)} = 1.23$ A, $V_{DS(MAX)} = 133.1$ V.

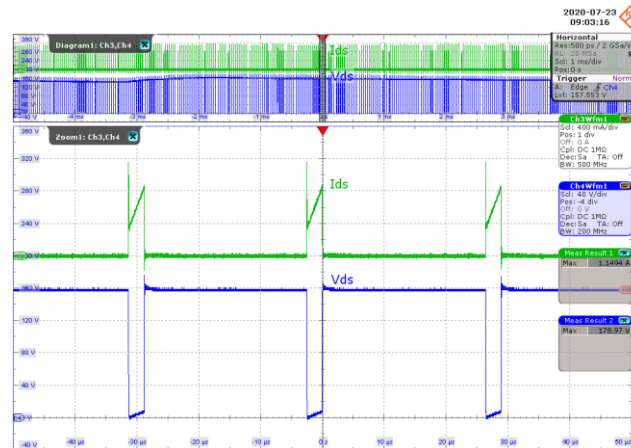

Figure 19 – Drain Voltage and Current Waveforms. 115 VAC, 550 mA Output. Upper: I_{DS} , 400 mA / div. Lower: V_{DS} , 40 V / div., 10 μ s / div. $I_{DS(MAX)} = 1.15$ A, $V_{DS(MAX)} = 179$ V.

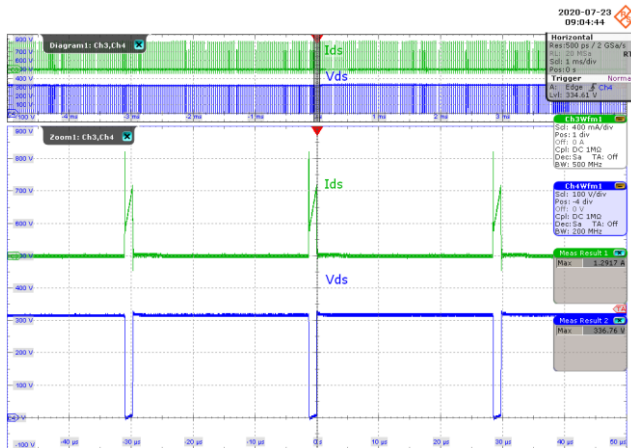

Figure 20 – Drain Voltage and Current Waveforms. 230 VAC, 550 mA Output. Upper: I_{DS} , 400 mA / div. Lower: V_{DS} , 100 V / div., 10 μ s / div. $I_{DS(MAX)} = 1.29$ A, $V_{DS(MAX)} = 336.8$ V.

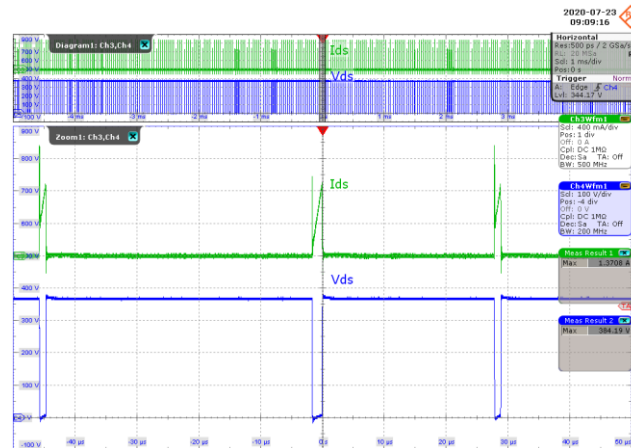

Figure 21 – Drain Voltage and Current Waveforms. 265 VAC, 550 mA Output. Upper: I_{DS} , 400 mA / div. Lower: V_{DS} , 100 V / div., 10 μ s / div. $I_{DS(MAX)} = 1.37$ A, $V_{DS(MAX)} = 384.2$ V.

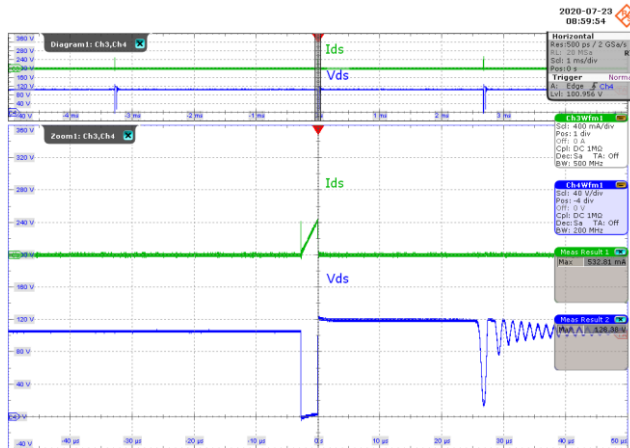

Figure 22 – Drain Voltage and Current Waveforms.
 85 VAC, 0 mA Output.
 Upper: I_{DS} , 400 mA / div.
 Lower: V_{DS} , 40 V / div., 10 μ s / div.
 $I_{DS(MAX)}$ = 0.532 A, $V_{DS(MAX)}$ = 128.4 V.

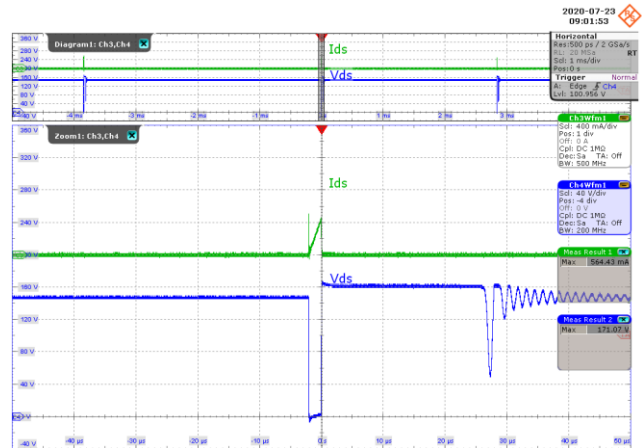

Figure 23 – Drain Voltage and Current Waveforms.
 115 VAC, 0 mA Output.
 Upper: I_{DS} , 400 mA / div.
 Lower: V_{DS} , 40 V / div., 10 μ s / div.
 $I_{DS(MAX)}$ = 0.564 A, $V_{DS(MAX)}$ = 171.1 V.

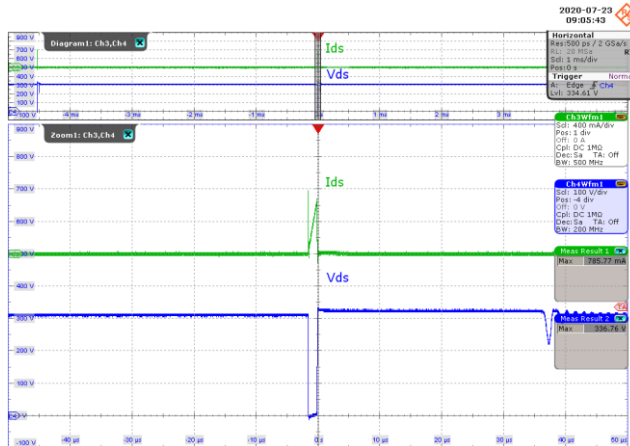

Figure 24 – Drain Voltage and Current Waveforms.
 230 VAC, 0 mA Output.
 Upper: I_{DS} , 400 mA / div.
 Lower: V_{DS} , 100 V / div., 10 μ s / div.
 $I_{DS(MAX)}$ = 0.786 A, $V_{DS(MAX)}$ = 336.8 V.

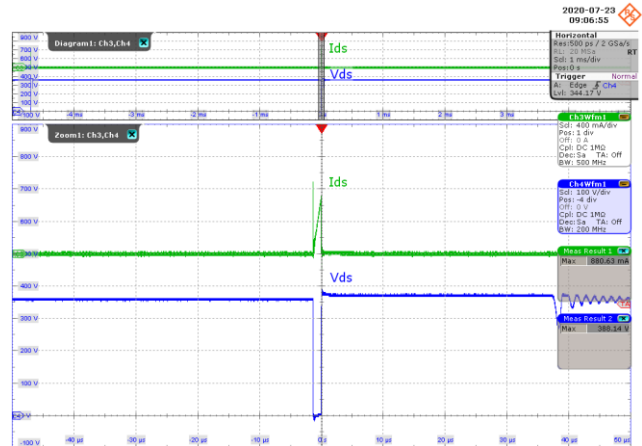

Figure 25 – Drain Voltage and Current Waveforms.
 265 VAC, 0 mA Output.
 Upper: I_{DS} , 400 mA / div.
 Lower: V_{DS} , 100 V / div., 10 μ s / div.
 $I_{DS(MAX)}$ = 0.881 A, $V_{DS(MAX)}$ = 388.1 V.



10.1.2 LNK3207D Drain Voltage and Current Waveforms During Start-Up

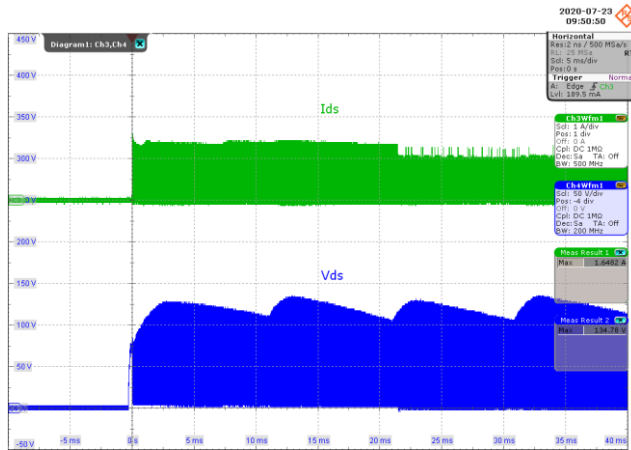

Figure 26 – Drain Voltage and Current Waveforms.
 85 VAC, 550 mA Output.
 Upper: I_{DS} , 1 A / div.
 Lower: V_{DS} , 50 V / div., 5 ms / div.
 $I_{DS(MAX)} = 1.65$ A, $V_{DS(MAX)} = 134.8$ V.

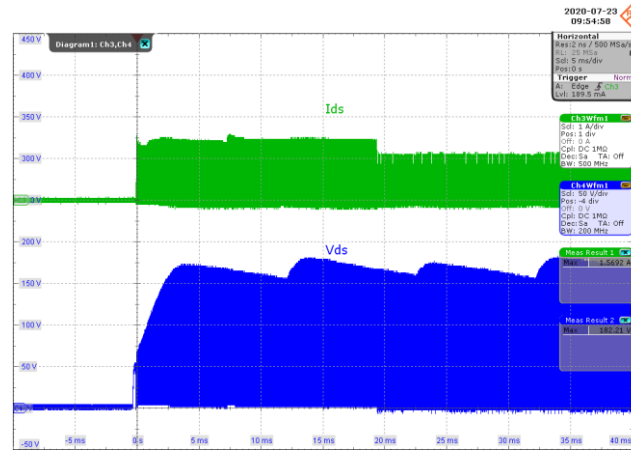

Figure 27 – Drain Voltage and Current Waveforms.
 115 VAC, 550 mA Output.
 Upper: I_{DS} , 1 A / div.
 Lower: V_{DS} , 50 V / div., 5 ms / div.
 $I_{DS(MAX)} = 1.57$ A, $V_{DS(MAX)} = 182.2$ V.

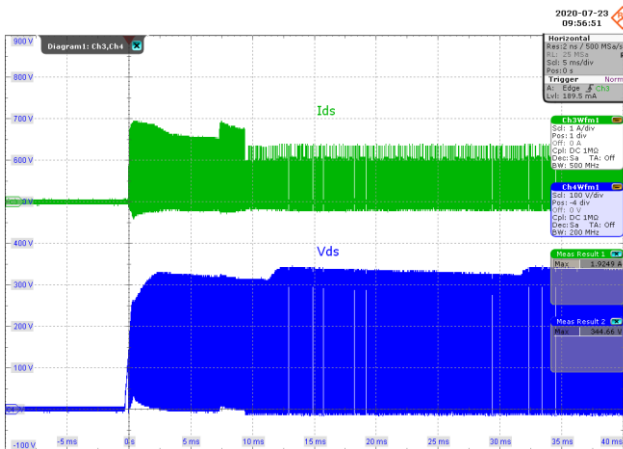

Figure 28 – Drain Voltage and Current Waveforms.
 230 VAC, 550 mA Output.
 Upper: I_{DS} , 1 A / div.
 Lower: V_{DS} , 100 V / div., 5 ms / div.
 $I_{DS(MAX)} = 1.93$ A, $V_{DS(MAX)} = 344.7$ V.

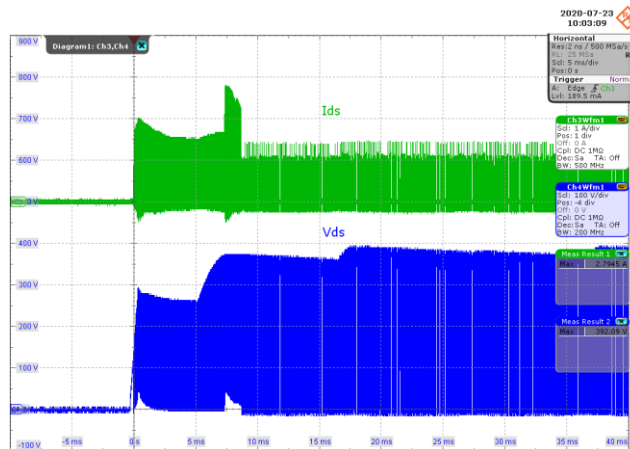

Figure 29 – Drain Voltage and Current Waveforms.
 265 VAC, 550 mA Output.
 Upper: I_{DS} , 1 A / div.
 Lower: V_{DS} , 100 V / div., 5 ms / div.
 $I_{DS(MAX)} = 2.79$ A, $V_{DS(MAX)} = 392.1$ V.

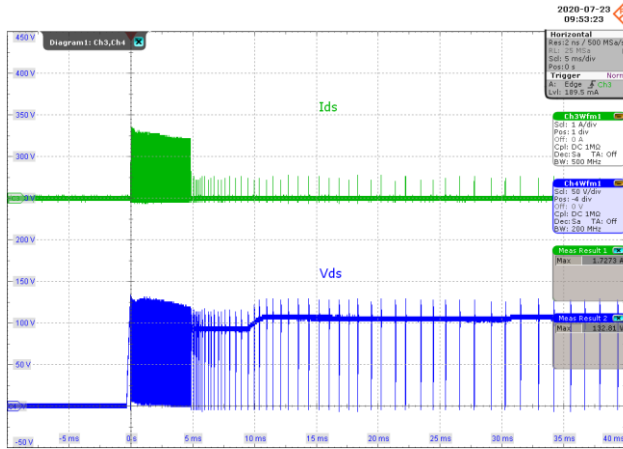

Figure 30 – Drain Voltage and Current Waveforms.
 85 VAC, 0 mA Output.
 Upper: I_{DS} , 1 A / div.
 Lower: V_{DS} , 50 V / div., 5 ms / div.
 $I_{DS(MAX)}$ = 1.73 A, $V_{DS(MAX)}$ = 132.8 V.

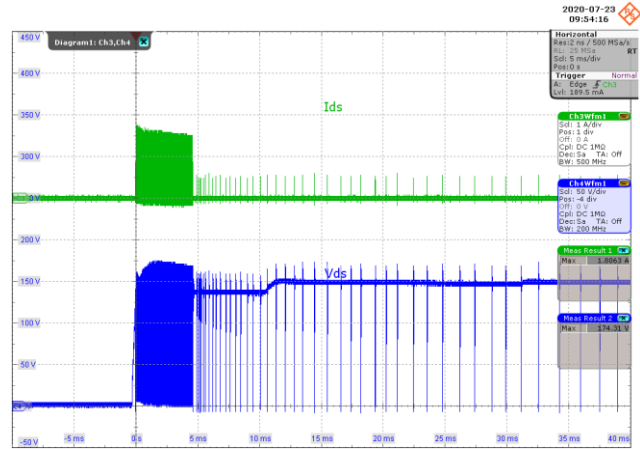

Figure 31 – Drain Voltage and Current Waveforms.
 115 VAC, 0 mA Output.
 Upper: I_{DS} , 1 A / div.
 Lower: V_{DS} , 50 V / div., 5 ms / div.
 $I_{DS(MAX)}$ = 1.81 A, $V_{DS(MAX)}$ = 174.3 V.

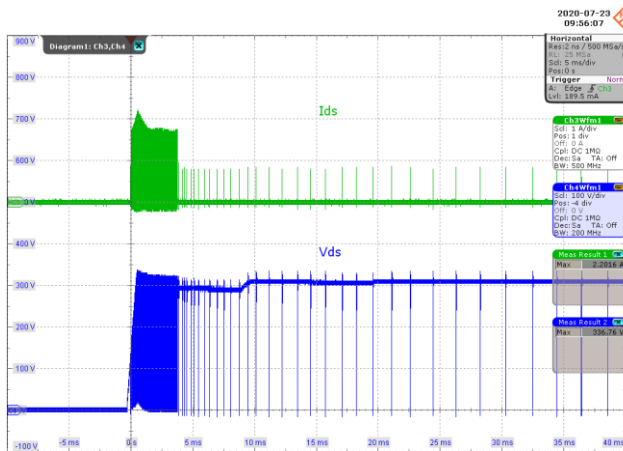

Figure 32 – Drain Voltage and Current Waveforms.
 230 VAC, 0 mA Output.
 Upper: I_{DS} , 1 A / div.
 Lower: V_{DS} , 100 V / div., 5 ms / div.
 $I_{DS(MAX)}$ = 2.20 A, V_{DS} max = 336.8 V.

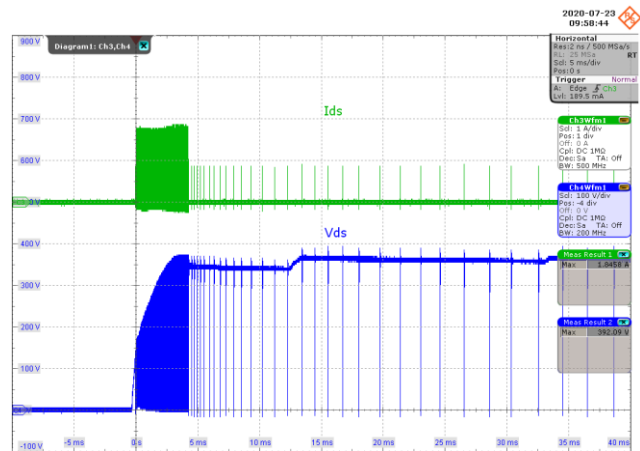

Figure 33 – Drain Voltage and Current Waveforms.
 265 VAC, 0 mA Output.
 Upper: I_{DS} , 1 A / div.
 Lower: V_{DS} , 100 V / div., 5 ms / div.
 $I_{DS(MAX)}$ = 1.85 A, $V_{DS(MAX)}$ = 392.1 V.



10.1.3 Drain Current and Output Waveform During Output Short

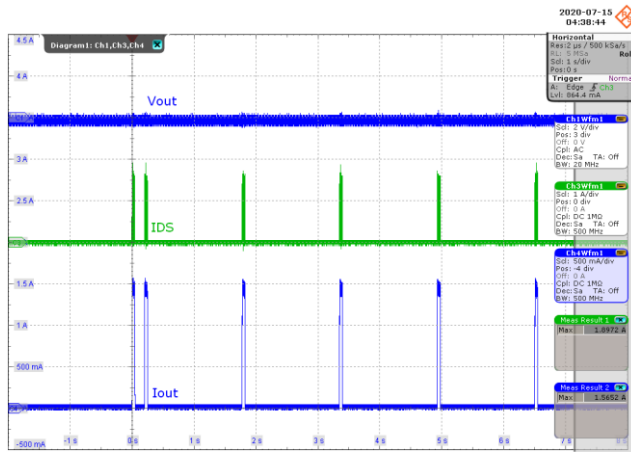

Figure 34 – Drain Current and Output Waveforms.
85 VAC Input.
Upper: V_{OUT} , 2 V / div, 1 s / div.
Middle: I_{DS} , 1 A / div.
Lower: I_{OUT} , 500 mA / div.

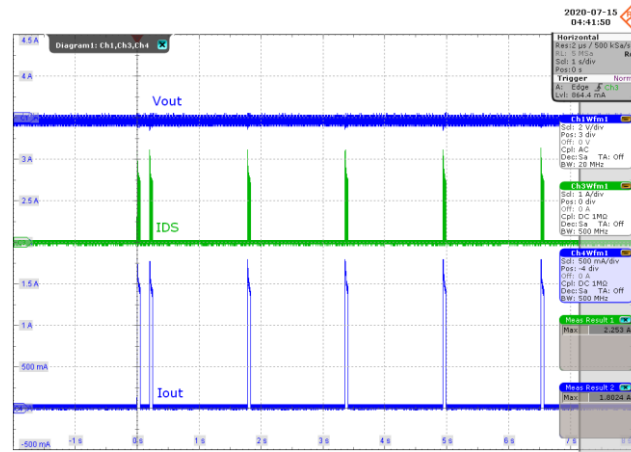

Figure 35 – Drain Voltage and Output Waveforms.
265 VAC Input.
Upper: V_{OUT} , 2 V / div, 1 s / div.
Middle: I_{DS} , 1 A / div.
Lower: I_{OUT} , 500 mA / div.

10.1.4 Freewheeling Diode Waveforms

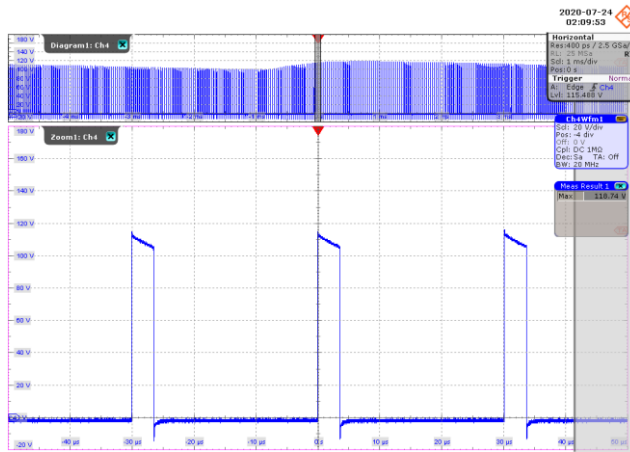

Figure 36 – Freewheeling Diode Voltage Waveforms.
85 VAC, 550 mA Output.
20 V / div., 10 μs / div.
 V_{MAX} : 118.7 V.

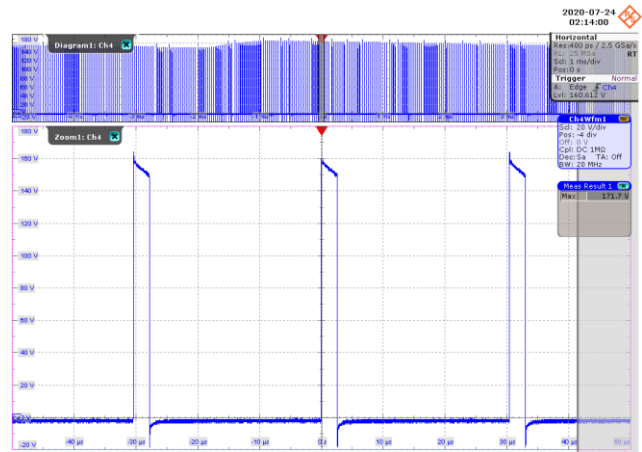

Figure 37 – Freewheeling Diode Voltage Waveforms.
115 VAC, 550 mA Output.
20 V / div., 10 μs / div.
 V_{MAX} : 171.7 V.

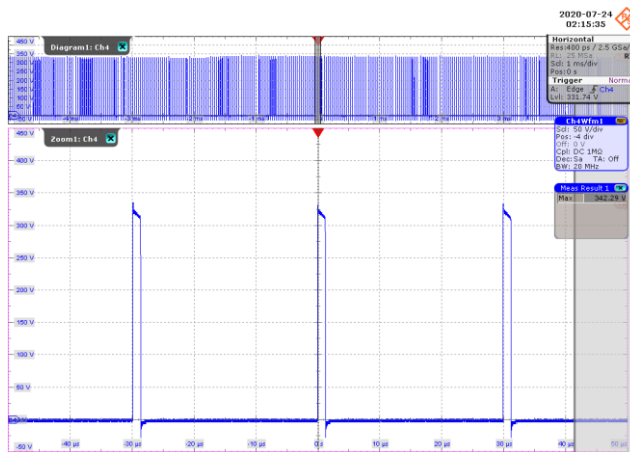

Figure 38 – Freewheeling Diode Voltage Waveforms.
230 VAC, 550 mA Output.
50 V / div., 10 μs / div.
 V_{MAX} : 342.3 V.

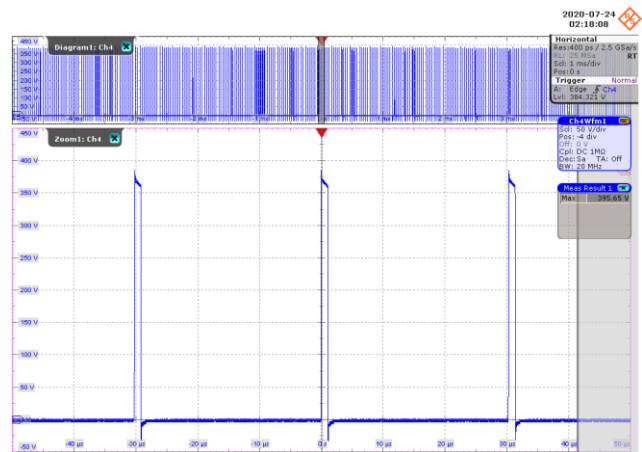

Figure 39 – Freewheeling Diode Voltage Waveforms.
265 VAC, 550 mA Output.
50 V / div., 10 μs / div.
 V_{MAX} : 395.7 V.



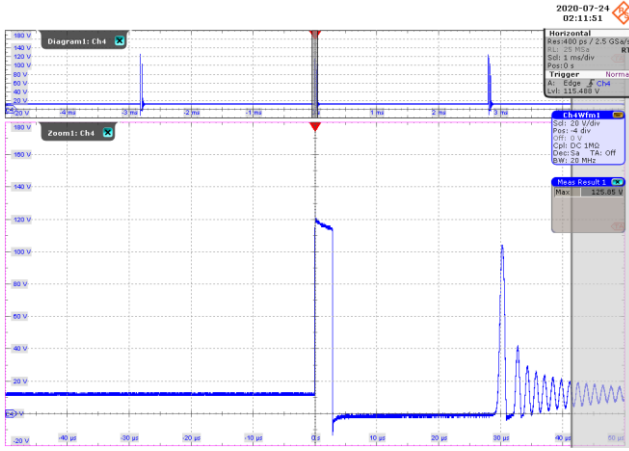

Figure 40 – Freewheeling Diode Voltage Waveforms.
85 VAC, 0 mA Output.
20 V / div., 10 μs / div.
 V_{MAX} : 125.9 V.

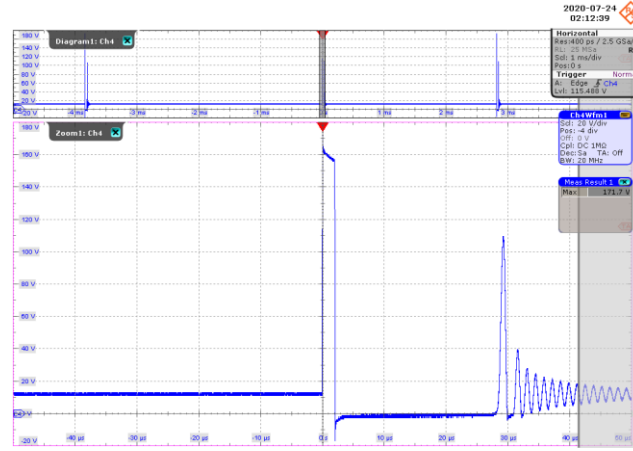

Figure 41 – Freewheeling Diode Voltage Waveforms.
115 VAC, 0 mA Output.
20 V / div., 10 μs / div.
 V_{MAX} : 171.7 V.

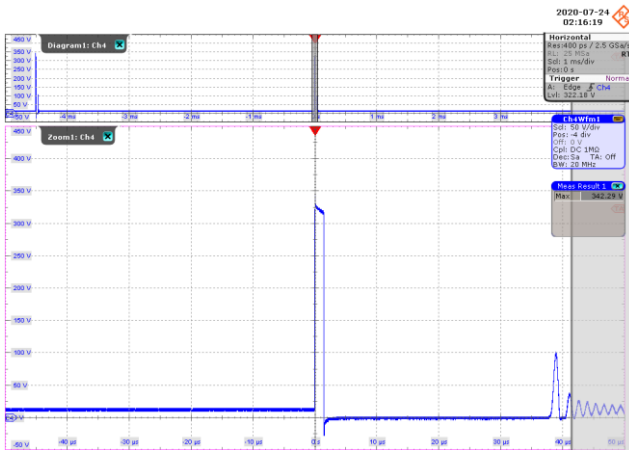

Figure 42 – Freewheeling Diode Voltage Waveforms.
230 VAC, 0 mA Output.
50 V / div., 10 μs / div.
 V_{MAX} : 342.3 V.

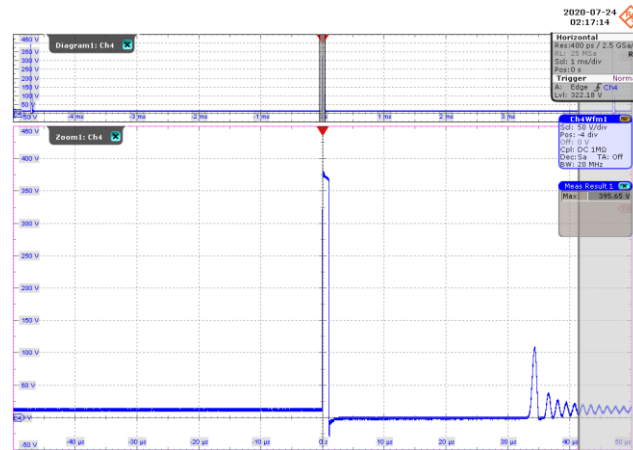

Figure 43 – Freewheeling Diode Voltage Waveforms.
265 VAC, 0 mA Output.
50 V / div., 10 μs / div.
 V_{MAX} : 395.7 V.

10.1.5 Freewheeling Diode Waveforms During Start-Up

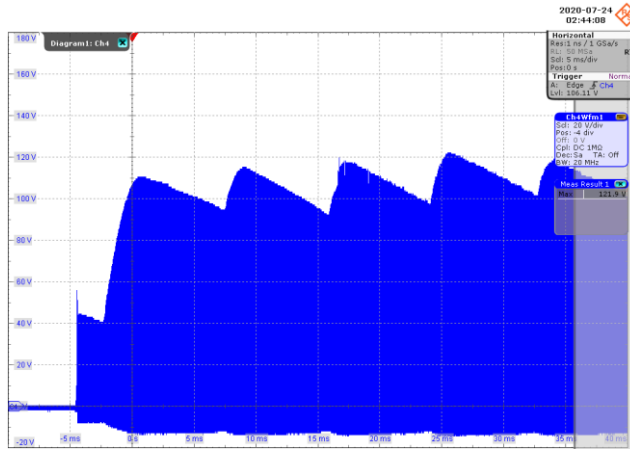

Figure 44 – Freewheeling Diode Voltage Waveforms.
85 VAC, 550 mA Output.
20 V / div., 5 ms / div
 V_{MAX} : 121.9 V.

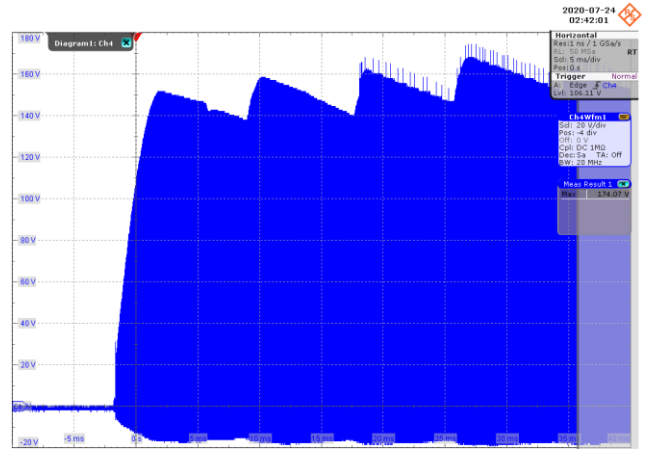

Figure 45 – Freewheeling Diode Voltage Waveforms.
115 VAC, 550 mA Output.
20 V / div., 5 ms / div.
 V_{MAX} : 174.1 V.

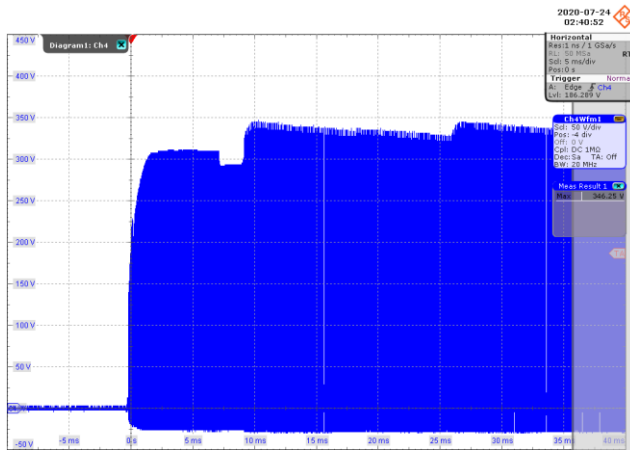

Figure 46 – Freewheeling Diode Voltage Waveforms.
230 VAC, 550 mA Output.
50 V / div., 5 ms / div
 V_{MAX} : 346.3 V.



Figure 47 – Freewheeling Diode Voltage Waveforms.
265 VAC, 550 mA Output.
50 V / div., 5 ms / div
 V_{MAX} : 401.6 V.



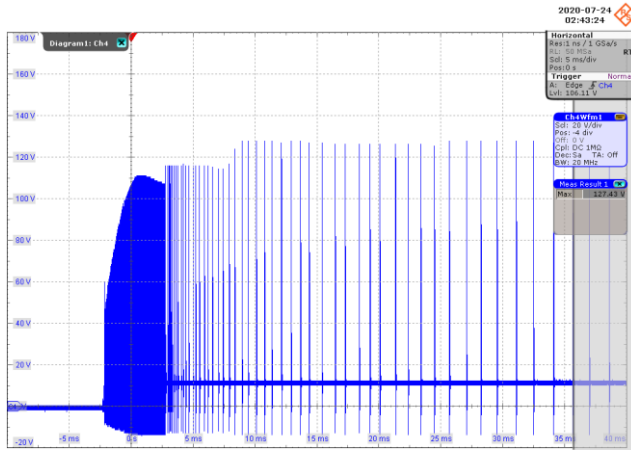

Figure 48 – Freewheeling Diode Voltage Waveforms.
85 VAC, 0 mA Output.
20 V / div., 5 ms / div
 V_{MAX} : 127.4 V.

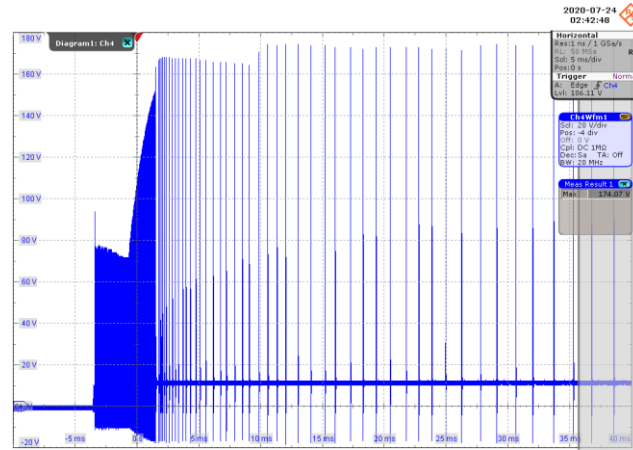

Figure 49 – Freewheeling Diode Voltage Waveforms.
115 VAC, 0 mA Output.
20 V / div., 5 ms / div.
 V_{MAX} : 174.1 V.

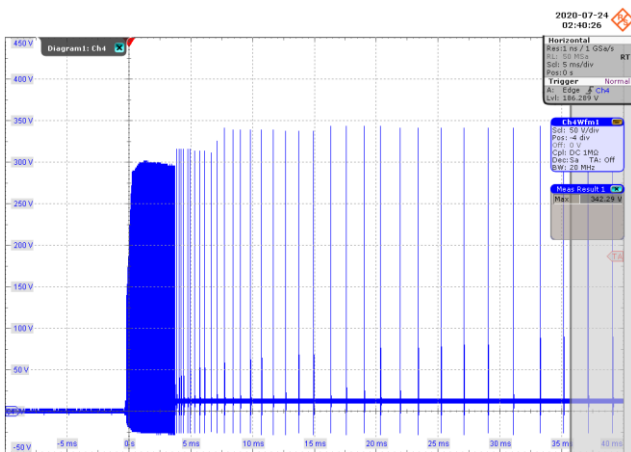

Figure 50 – Freewheeling Diode Voltage Waveforms.
230 VAC, 0 mA Output.
50 V / div., 5 ms / div
 V_{MAX} : 342.3 V.

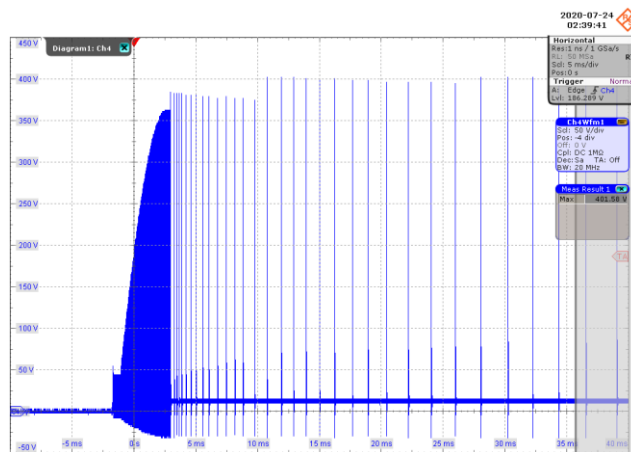

Figure 51 – Freewheeling Diode Voltage Waveforms.
265 VAC, 0 mA Output.
50 V / div., 5 ms / div
 V_{MAX} : 401.6 V.

10.1.6 Output Voltage and Current Waveforms During Start-Up (CC mode)

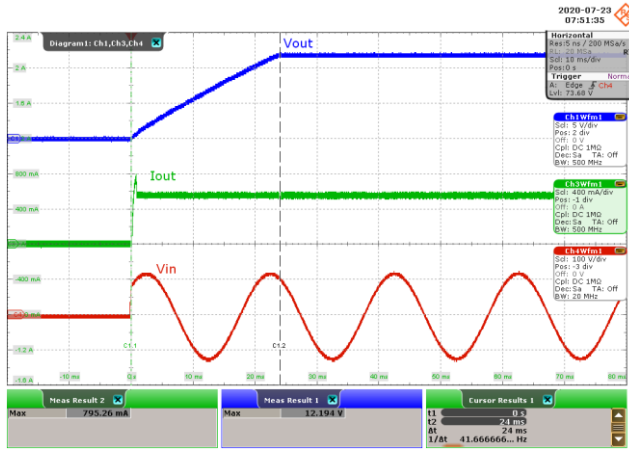

Figure 52 – Output Voltage and Current Waveforms. 85 VAC, 550 mA Output.
 Upper: V_{OUT} , 5 V / div., 10 ms / div.
 Middle: I_{OUT} 400 mA / div.
 Lower: V_{IN} , 100 V / div.
 Rise Time = 24 ms.

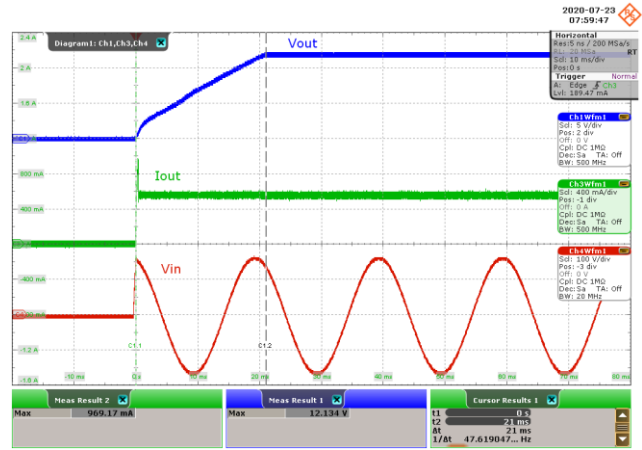

Figure 53 – Output Voltage and Current Waveforms. 115 VAC, 550 mA Output.
 Upper: V_{OUT} , 5 V / div., 10 ms / div.
 Middle: I_{OUT} 400 mA / div.
 Lower: V_{IN} , 100 V / div.
 Rise Time = 21 ms.

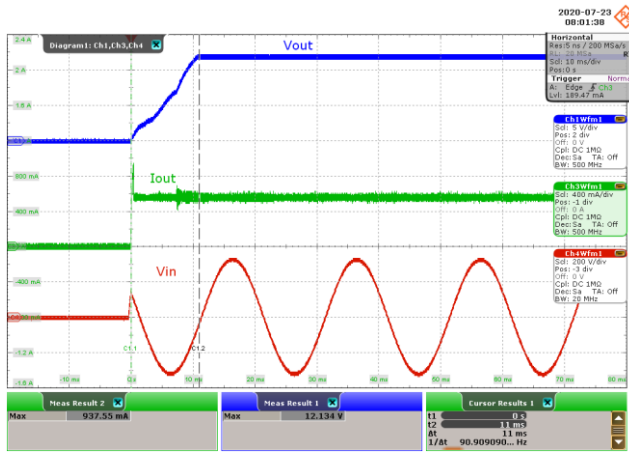

Figure 54 – Output Voltage and Current Waveforms. 230 VAC, 550 mA Output.
 Upper: V_{OUT} , 5 V / div., 10 ms / div.
 Middle: I_{OUT} 400 mA / div.
 Lower: V_{IN} , 200 V / div.
 Rise Time = 11 ms.

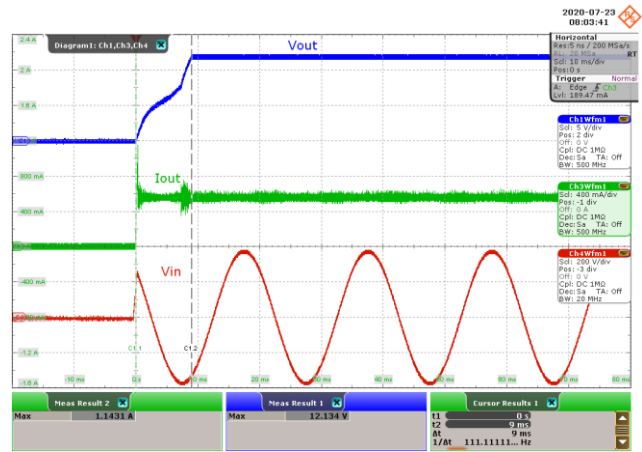

Figure 55 – Output Voltage and Current Waveforms. 265 VAC, 550 mA Output.
 Upper: V_{OUT} , 5 V / div., 10 ms / div.
 Middle: I_{OUT} 400 mA / div.
 Lower: V_{IN} , 200 V / div.
 Rise Time = 9 ms.



10.1.7 Output Voltage and Current Waveforms During Start-Up (CR mode)

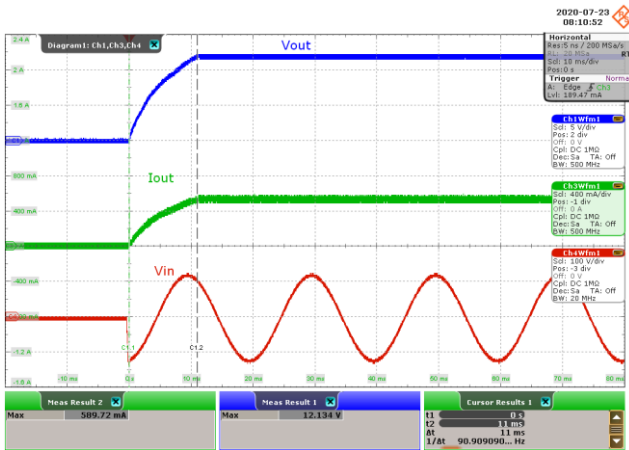

Figure 56 – Output Voltage and Current Waveforms. 85 VAC, 21.8 Ω Load.
 Upper: V_{OUT} , 5 V / div., 10 ms / div.
 Middle: I_{OUT} 400 mA / div.
 Lower: V_{IN} , 100 V / div.
 Rise Time = 11 ms.

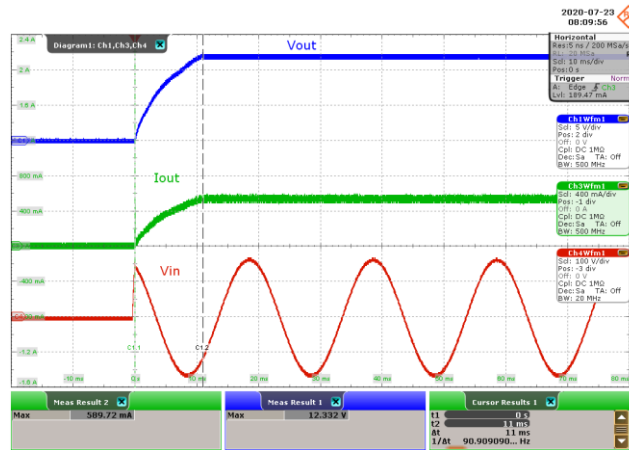

Figure 57 – Output Voltage and Current Waveforms. 115 VAC, 21.8 Ω Load.
 Upper: V_{OUT} , 5 V / div., 10 ms / div.
 Middle: I_{OUT} 400 mA / div.
 Lower: V_{IN} , 100 V / div.
 Rise Time = 11 ms.

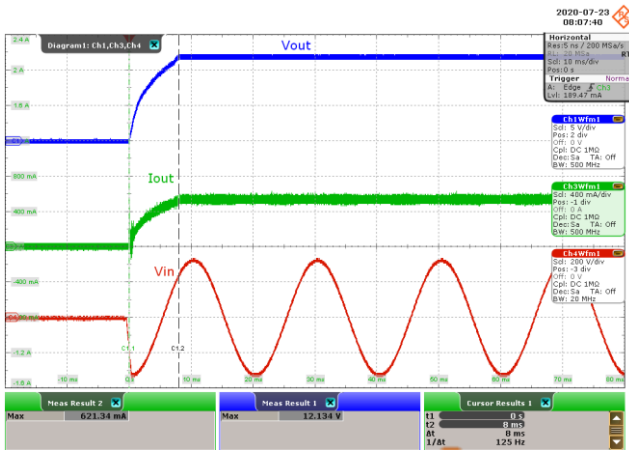

Figure 58 – Output Voltage and Current Waveforms. 230 VAC, 21.8 Ω Load.
 Upper: V_{OUT} , 5 V / div., 10 ms / div.
 Middle: I_{OUT} 400 mA / div.
 Lower: V_{IN} , 200 V / div.
 Rise Time = 8 ms.

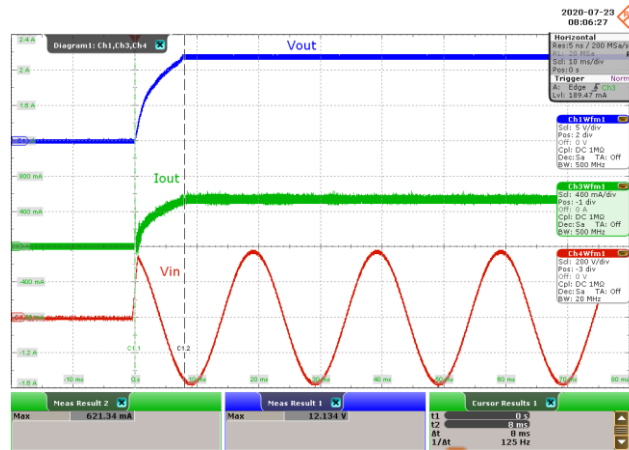

Figure 59 – Output Voltage and Current Waveforms. 265 VAC, 21.8 Ω Load.
 Upper: V_{OUT} , 5 V / div., 10 ms / div.
 Middle: I_{OUT} 400 mA / div.
 Lower: V_{IN} , 200 V / div.
 Rise Time = 8 ms.

10.1.8 Output Voltage and Current Waveforms During Start-Up (No-Load)

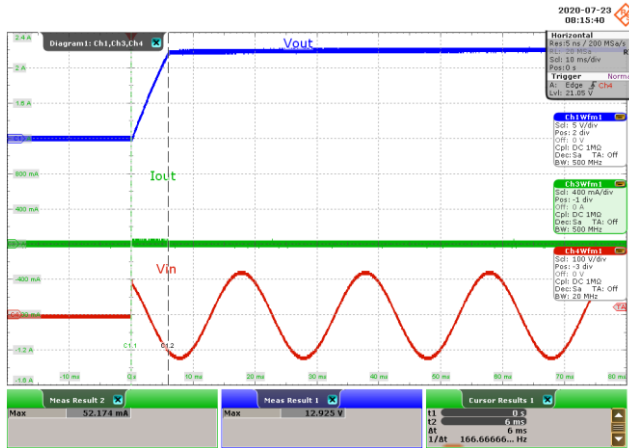

Figure 60 – Output Voltage and Current Waveforms.
 85 VAC, 0 mA Output.
 Upper: V_{OUT} , 5 V / div., 10 ms / div.
 Middle: I_{OUT} 400 mA / div.
 Lower: V_{IN} , 100 V / div.
 Rise Time = 6 ms.

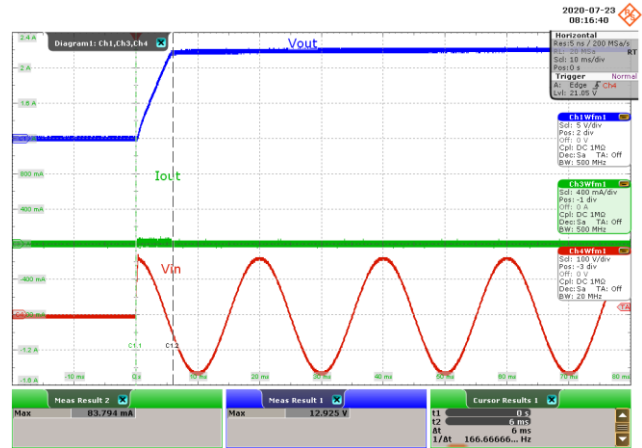

Figure 61 – Output Voltage and Current Waveforms.
 115 VAC, 0 mA Output.
 Upper: V_{OUT} , 5 V / div., 10 ms / div.
 Middle: I_{OUT} 400 mA / div.
 Lower: V_{IN} , 100 V / div.
 Rise Time = 6 ms.

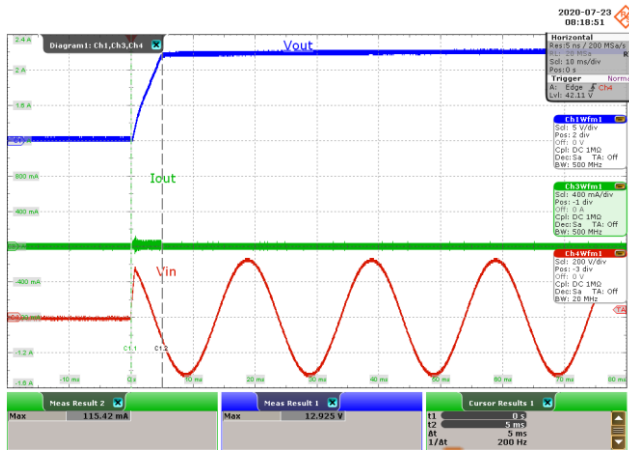

Figure 62 – Output Voltage and Current Waveforms.
 85 VAC, 0 mA Output.
 Upper: V_{OUT} , 5 V / div., 10 ms / div.
 Middle: I_{OUT} 400 mA / div.
 Lower: V_{IN} , 200 V / div.
 Rise Time = 5 ms.

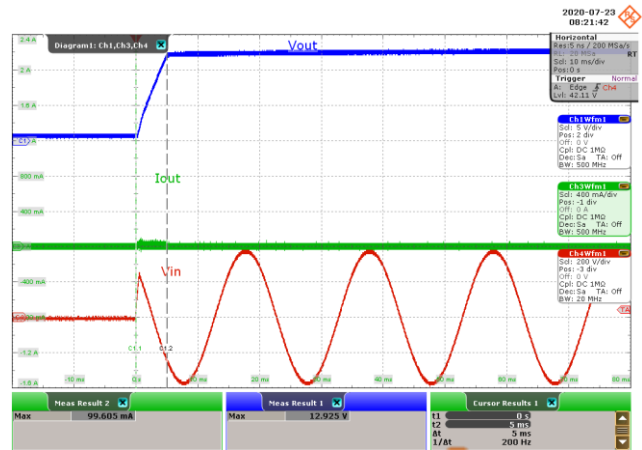

Figure 63 – Output Voltage and Current Waveforms.
 265 VAC, 0 mA Output.
 Upper: V_{OUT} , 5 V / div., 10 ms / div.
 Middle: I_{OUT} 400 mA / div.
 Lower: V_{IN} , 200 V / div.
 Rise Time = 5 ms.



10.2 **Output Ripple Measurements**

10.2.1 Ripple Measurement Technique

For DC output ripple measurements, a modified oscilloscope test probe must be utilized in order to reduce spurious signals due to pick-up. Details of the probe modification are provided in the Figures below.

The 4987BA probe adapter is affixed with two capacitors tied in parallel across the probe tip. The capacitors include one (1) 0.1 $\mu\text{F}/50\text{ V}$ ceramic type and one (1) 1 $\mu\text{F}/50\text{ V}$ aluminum electrolytic. The aluminum electrolytic type capacitor is polarized, so proper polarity across DC outputs must be maintained (see below).

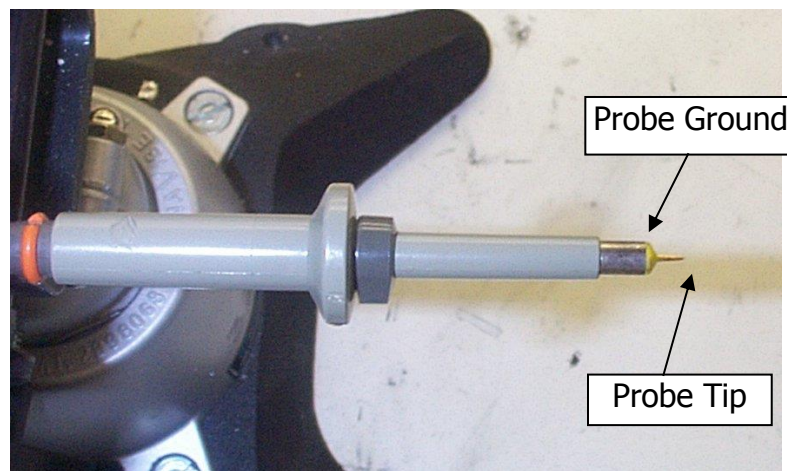

Figure 64 – Oscilloscope Probe Prepared for Ripple Measurement. (End Cap and Ground Lead Removed.)

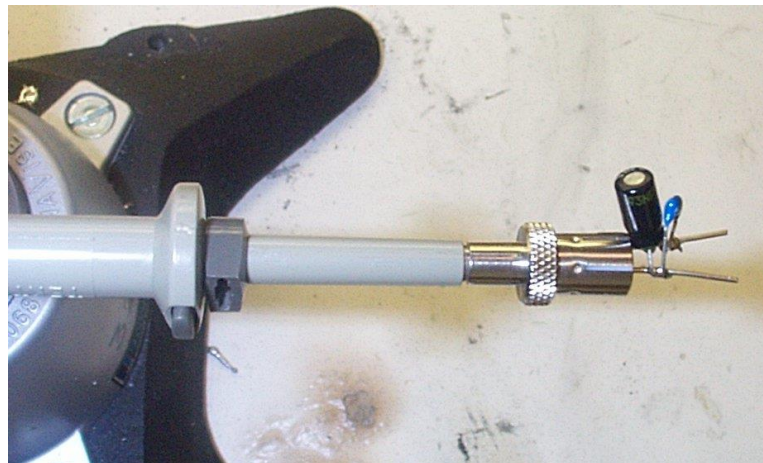

Figure 65 – Oscilloscope Probe with Probe Master (www.probemaster.com) 4987A BNC Adapter. (Modified with wires for ripple measurement, and two parallel decoupling capacitors added.)

10.2.2 Measurement Results

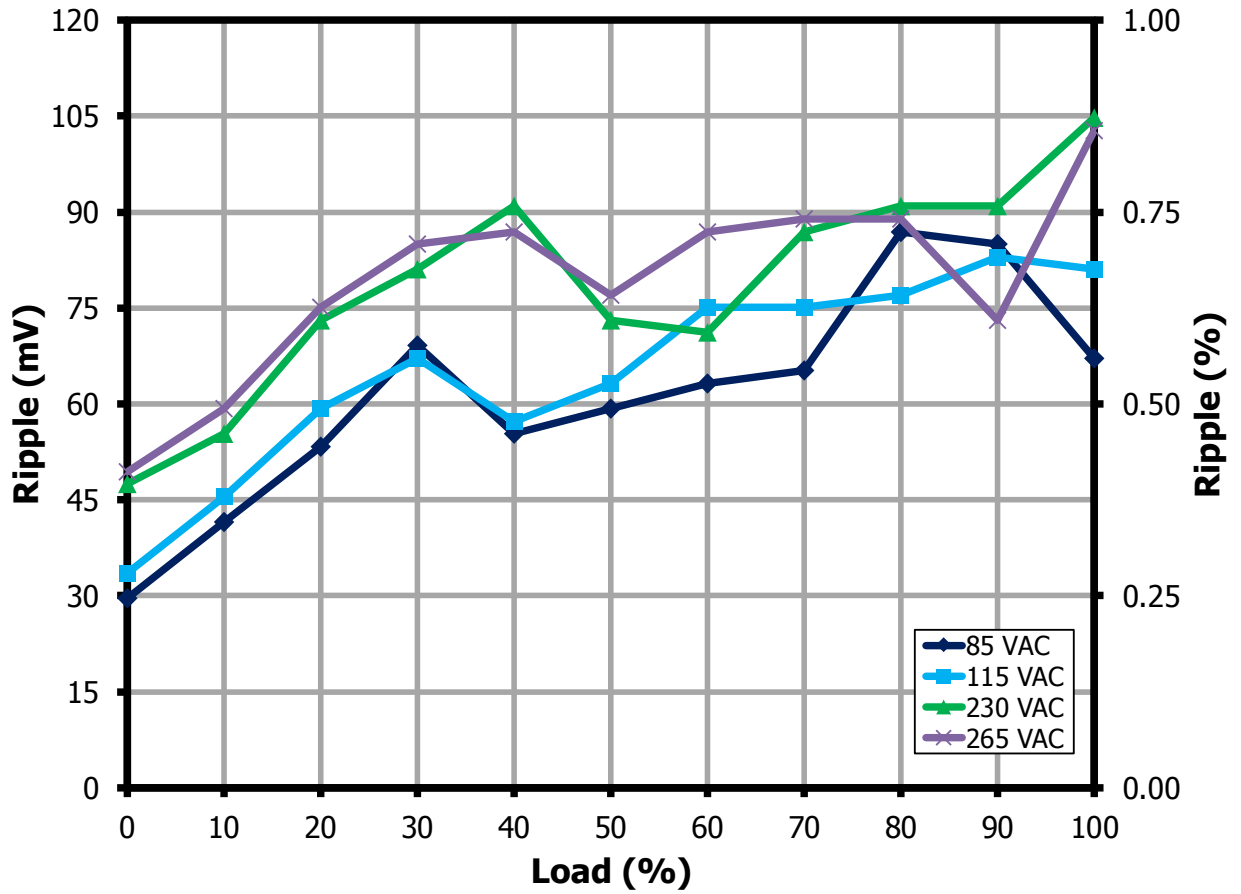

Figure 66 – Output Ripple Voltage.



10.2.3 Ripple Voltage Waveforms

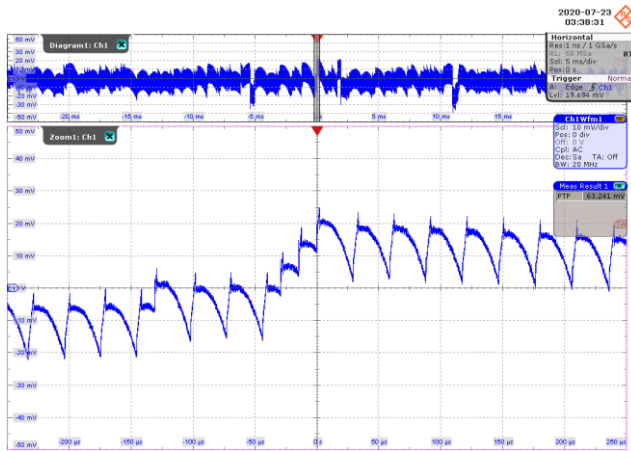

Figure 67 – Output Voltage Ripple Waveforms.
 85 VAC, 550 mA Output.
 10 mV, 5 ms / div.; 50 μ s / div.
 V_{PK-PK} : 63.2 mV.

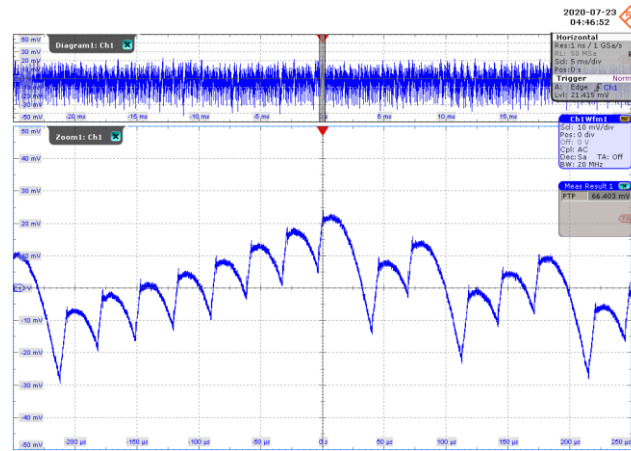

Figure 68 – Output Voltage Ripple Waveforms.
 85 VAC, 412.5 mA Output.
 10 mV, 5 ms / div.; 50 μ s / div.
 V_{PK-PK} : 66.4 mV.

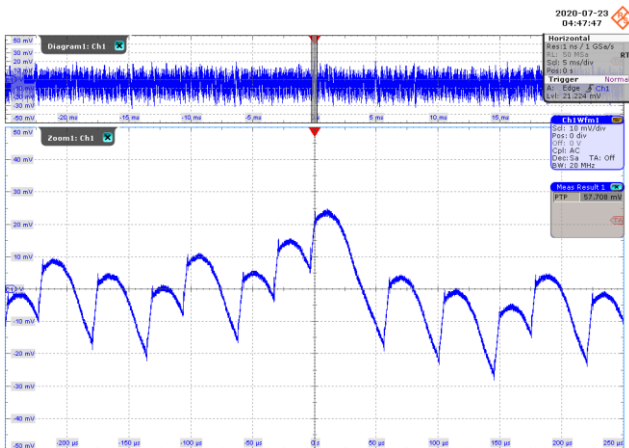

Figure 69 – Output Voltage Ripple Waveforms.
 85 VAC, 275 mA Output.
 10 mV, 5 ms / div.; 50 μ s / div.
 V_{PK-PK} : 57.7 mV.

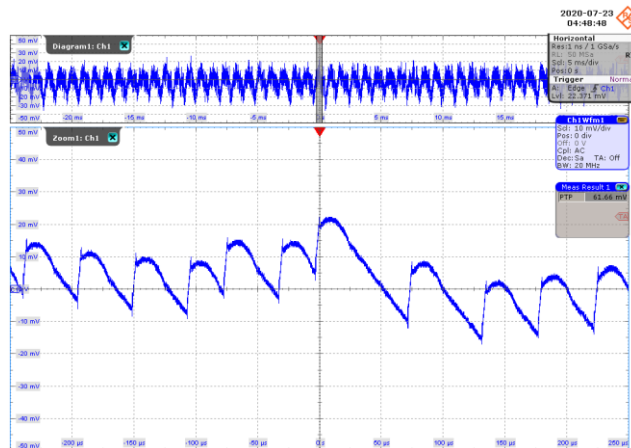

Figure 70 – Output Voltage Ripple Waveforms.
 85 VAC, 137.5 mA Output.
 10 mV, 5 ms / div.; 50 μ s / div.
 V_{PK-PK} : 61.7 mV.

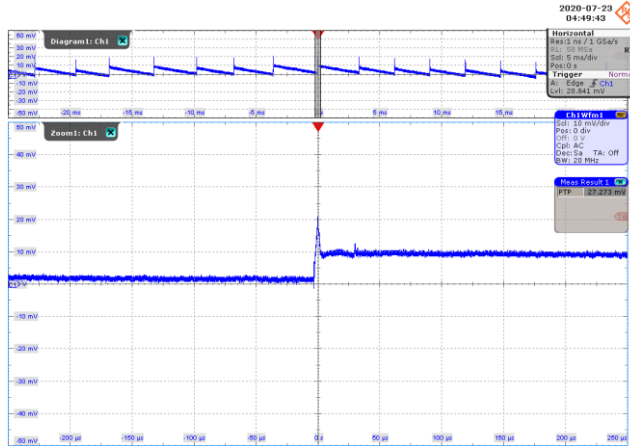

Figure 71 – Output Voltage Ripple Waveforms.
 85 VAC, 0 mA Output.
 10 mV, 5 ms / div.; 50 μ s / div.
 V_{PK-PK} : 27.3 mV.

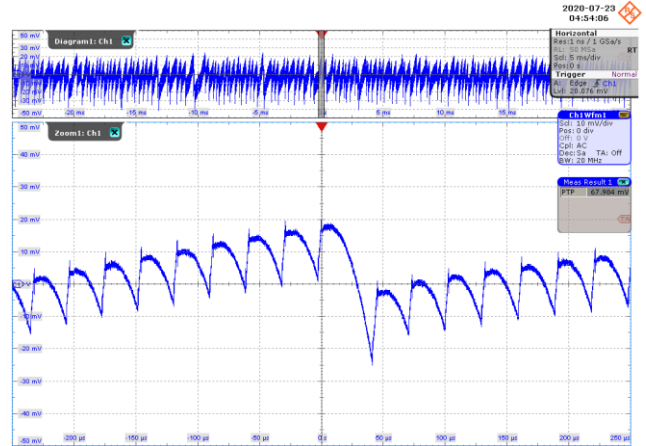

Figure 72 – Output Voltage Ripple Waveforms.
 115 VAC, 550 mA Output.
 10 mV, 5 ms / div.; 50 μ s / div.
 V_{PK-PK} : 68.0 mV.

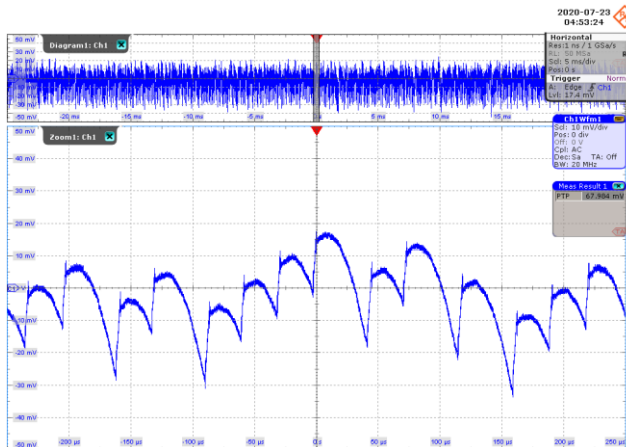

Figure 73 – Output Voltage Ripple Waveforms.
 115 VAC, 412.5 mA Output.
 10 mV, 5 ms / div.; 50 μ s / div.
 V_{PK-PK} : 68.0 mV.

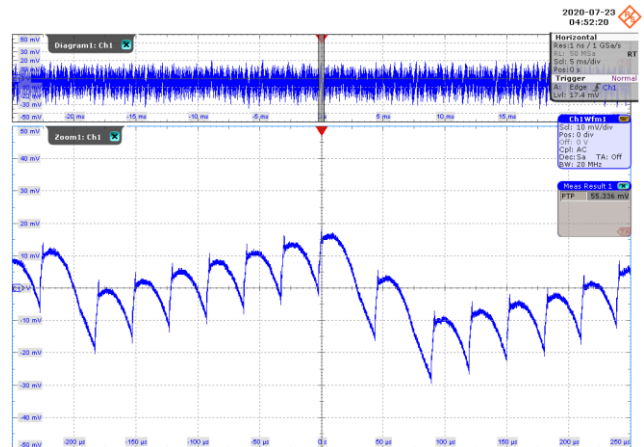

Figure 74 – Output Voltage Ripple Waveforms.
 115 VAC, 275 mA Output.
 10 mV, 5 ms / div.; 50 μ s / div.
 V_{PK-PK} : 55.3 mV.



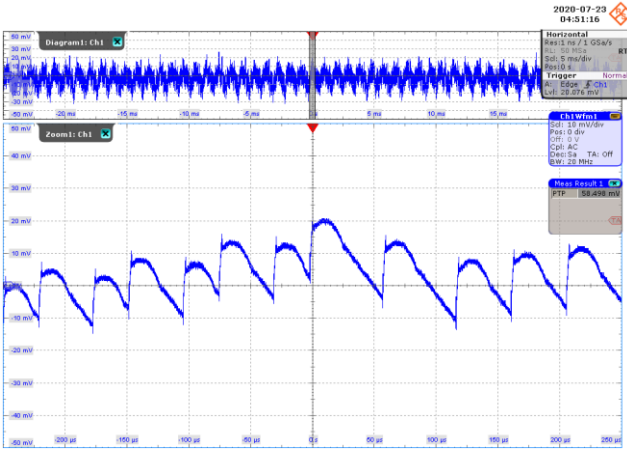

Figure 75 – Output Voltage Ripple Waveforms.
 115 VAC, 137.5 mA Output.
 10 mV, 5 ms / div.; 50 μ s / div.
 V_{PK-PK} : 58.5 mV.

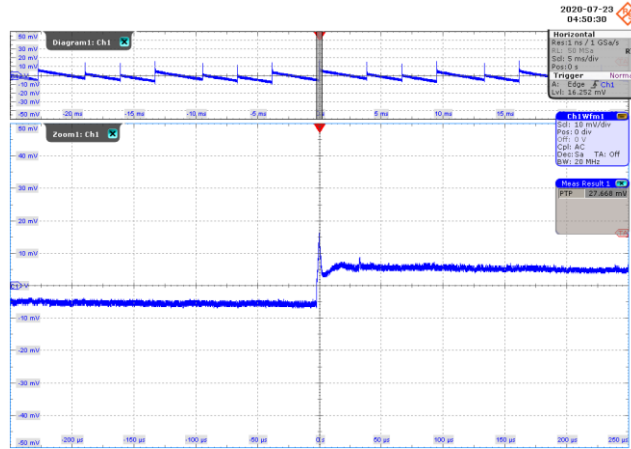

Figure 76 – Output Voltage Ripple Waveforms.
 115 VAC, 0 mA Output.
 10 mV, 5 ms / div.; 50 μ s / div.
 V_{PK-PK} : 27.7 mV.

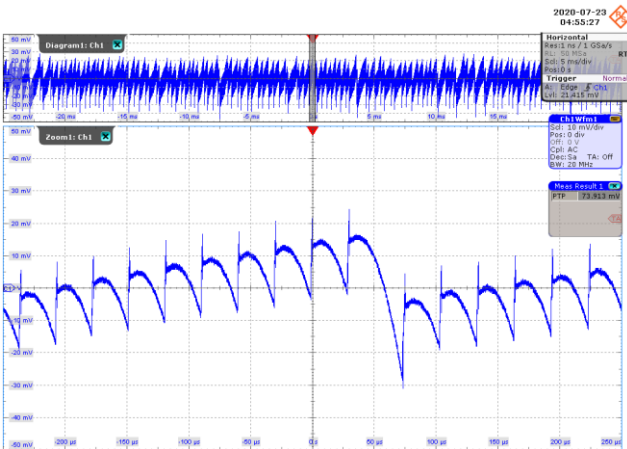

Figure 77 – Output Voltage Ripple Waveforms.
 230 VAC, 550 mA Output.
 10 mV, 5 ms / div.; 50 μ s / div.
 V_{PK-PK} : 73.9 mV.

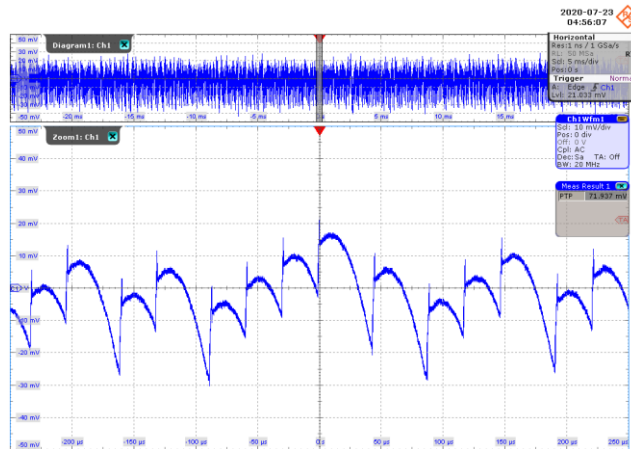

Figure 78 – Output Voltage Ripple Waveforms.
 230 VAC, 412.5 mA Output.
 10 mV, 5 ms / div.; 50 μ s / div.
 V_{PK-PK} : 71.9 mV.

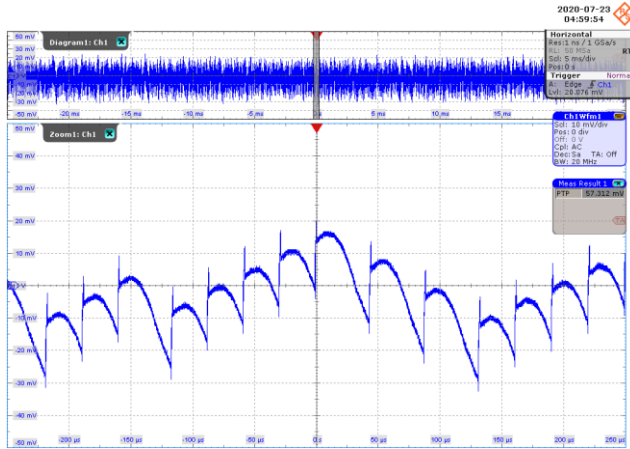

Figure 79 – Output Voltage Ripple Waveforms.
 230 VAC, 275 mA Output.
 10 mV, 5 ms / div.; 50 μ s / div.
 V_{PK-PK} : 57.3 mV.

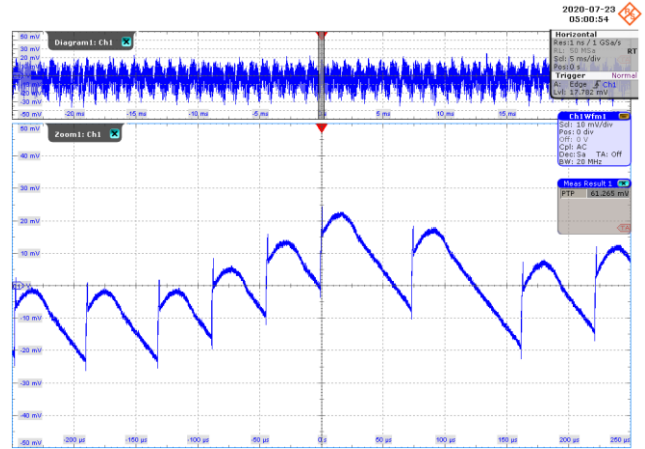

Figure 80 – Output Voltage Ripple Waveforms.
 230 VAC, 137.5 mA Output.
 10 mV, 5 ms / div.; 50 μ s / div.
 V_{PK-PK} : 61.3 mV.

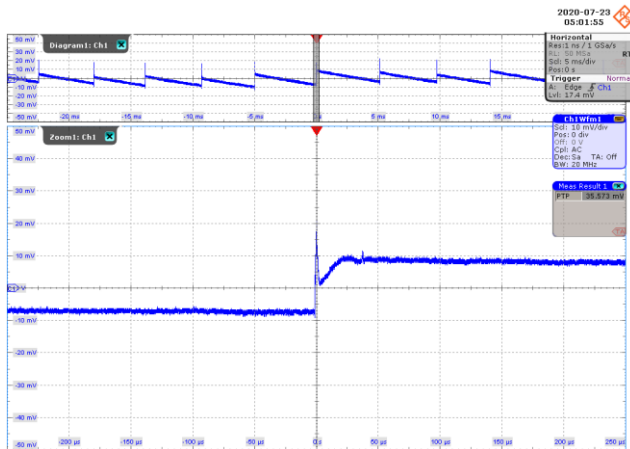

Figure 81 – Output Voltage Ripple Waveforms.
 230 VAC, 0 mA Output.
 10 mV, 5 ms / div.; 50 μ s / div.
 V_{PK-PK} : 35.6 mV.

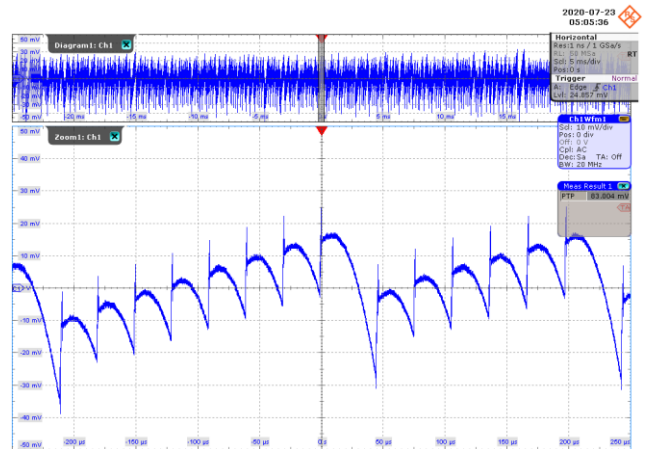

Figure 82 – Output Voltage Ripple Waveforms.
 265 VAC, 550 mA Output.
 10 mV, 5 ms / div.; 50 μ s / div.
 V_{PK-PK} : 83.0 mV.

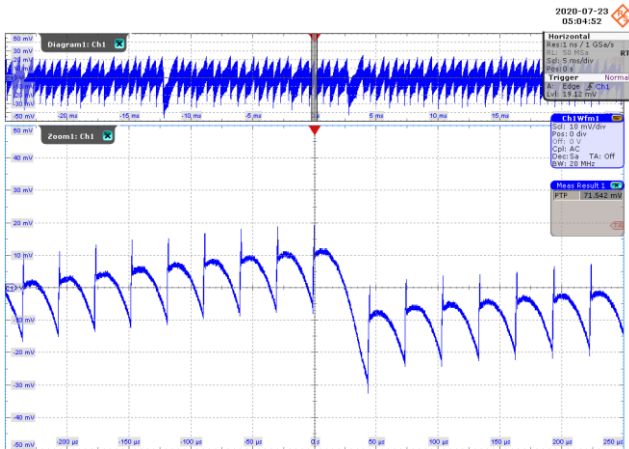

Figure 83 – Output Voltage Ripple Waveforms.
 265 VAC, 412.5 mA Output.
 10 mV, 5 ms / div.; 50 μ s / div.
 V_{PK-PK} : 71.5 mV.

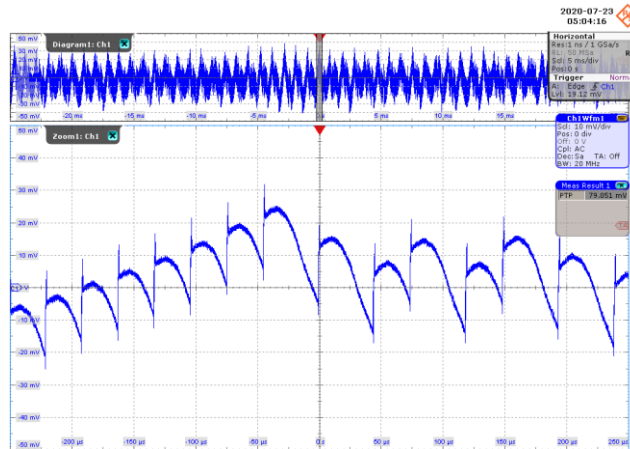

Figure 84 – Output Voltage Ripple Waveforms.
 265 VAC, 275 mA Output.
 10 mV, 5 ms / div.; 50 μ s / div.
 V_{PK-PK} : 79.1 mV.

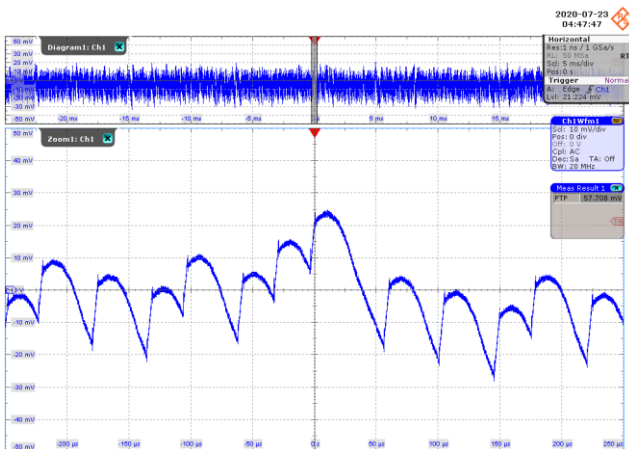

Figure 85 – Output Voltage Ripple Waveforms.
 265 VAC, 137.5 mA Output.
 10 mV, 5 ms / div.; 50 μ s / div.
 V_{PK-PK} : 57.7 mV.

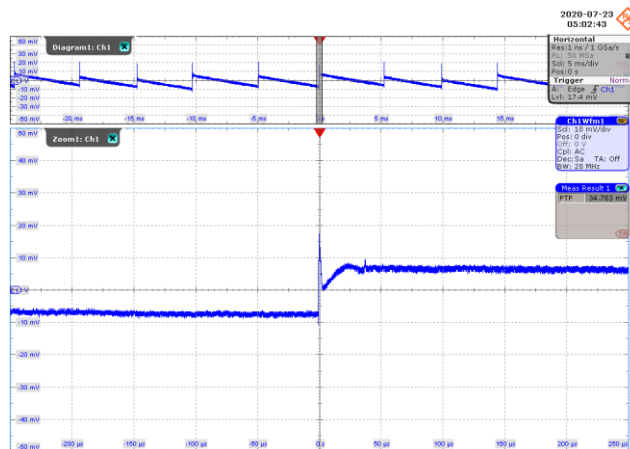

Figure 86 – Output Voltage Ripple Waveforms.
 265 VAC, 0 mA Output.
 10 mV, 5 ms / div.; 50 μ s / div.
 V_{PK-PK} : 34.8 mV.

10.2.4 Transient Response

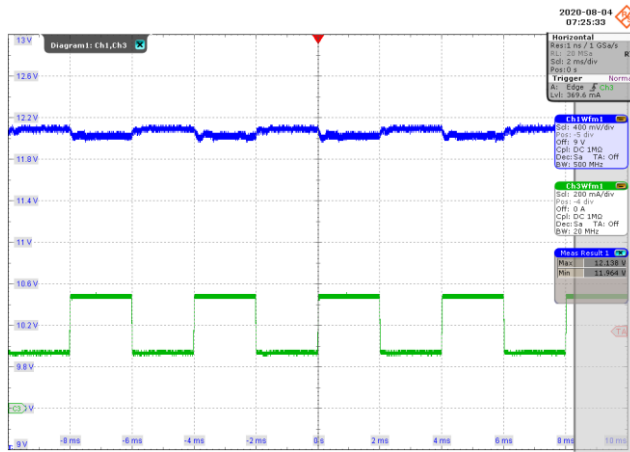

Figure 87 – Transient Output Waveforms.
 85 VAC.
 Upper: V_{OUT} , 400 mV / div., 2 ms / div.
 Lower: I_{OUT} 200 mA / div.
 Load Transient: 50 % - 100%.
 Duty Cycle, Slew Rate: 50%, 0.8 A / μ s.
 Frequency: 250 Hz.
 V_{MAX} : 12.14 V, V_{MIN} : 11.96 V.

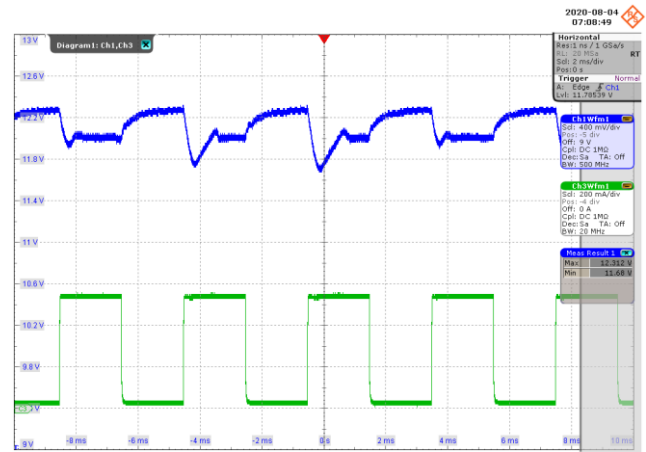

Figure 88 – Transient Output Waveforms.
 85 VAC.
 Upper: V_{OUT} , 400 mV / div., 2 ms / div.
 Lower: I_{OUT} 200 mA / div.
 Load Transient: 5 % - 100%.
 Duty Cycle, Slew Rate: 50%, 0.8 A / μ s.
 Frequency: 250 Hz.
 V_{MAX} : 12.31 V, V_{MIN} : 11.68 V.

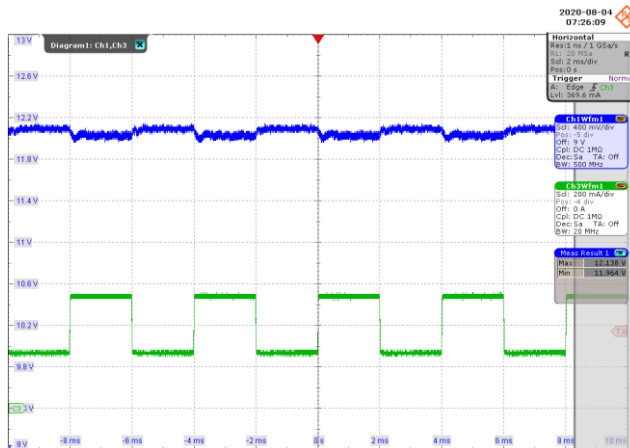

Figure 89 – Transient Output Waveforms.
 115 VAC.
 Upper: V_{OUT} , 400 mV / div., 2 ms / div.
 Lower: I_{OUT} 200 mA / div.
 Load Transient: 50 % - 100%.
 Duty Cycle, Slew Rate: 50%, 0.8 A / μ s.
 Frequency: 250 Hz.
 V_{MAX} : 12.14 V, V_{MIN} : 11.96 V.

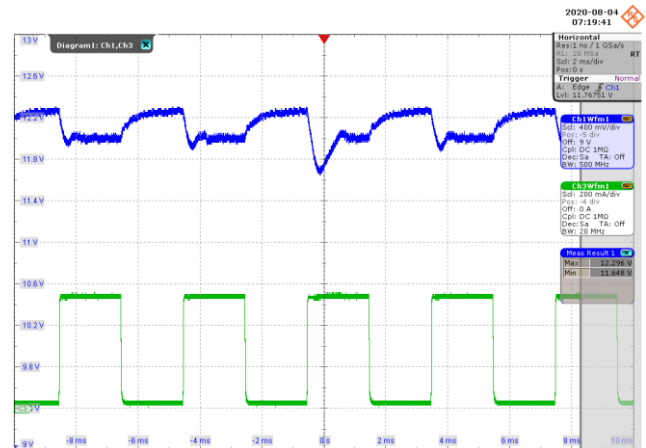

Figure 90 – Transient Output Waveforms.
 115 VAC.
 Upper: V_{OUT} , 400 mV / div., 2 ms / div.
 Lower: I_{OUT} 200 mA / div.
 Load Transient: 5 % - 100%.
 Duty Cycle, Slew Rate: 50%, 0.8 A / μ s.
 Frequency: 250 Hz.
 V_{MAX} : 12.30 V, V_{MIN} : 11.65 V.



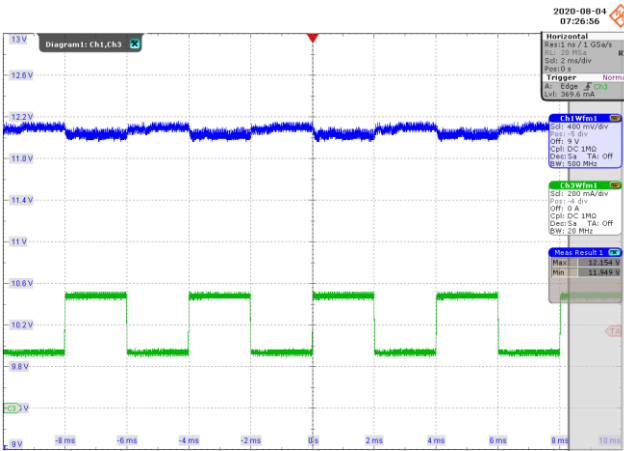

Figure 91 – Transient Output Waveforms.
 230 VAC.
 Upper: V_{OUT} , 400 mV / div., 2 ms / div.
 Lower: I_{OUT} 200 mA / div.
 Load Transient: 50 % - 100%.
 Duty Cycle, Slew Rate: 50%, 0.8 A / μ s.
 Frequency: 250 Hz.
 V_{MAX} : 12.15 V, V_{MIN} : 11.95 V.

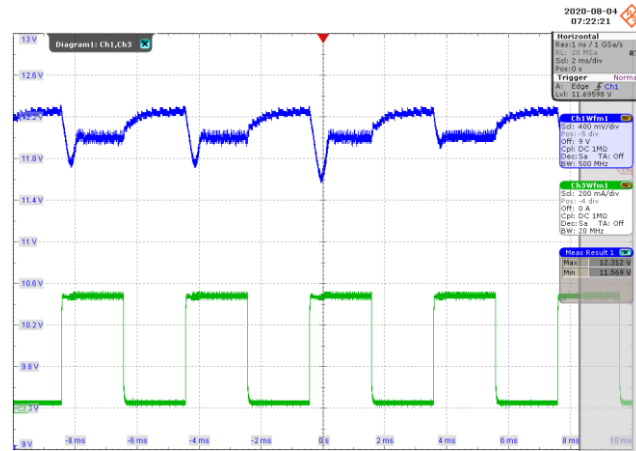

Figure 92 – Transient Output Waveforms.
 230 VAC.
 Upper: V_{OUT} , 400 mV / div., 2 ms / div.
 Lower: I_{OUT} 200 mA / div.
 Load Transient: 5 % - 100%.
 Duty Cycle, Slew Rate: 50%, 0.8 A / μ s.
 Frequency: 250 Hz.
 V_{MAX} : 12.31 V, V_{MIN} : 11.57 V.

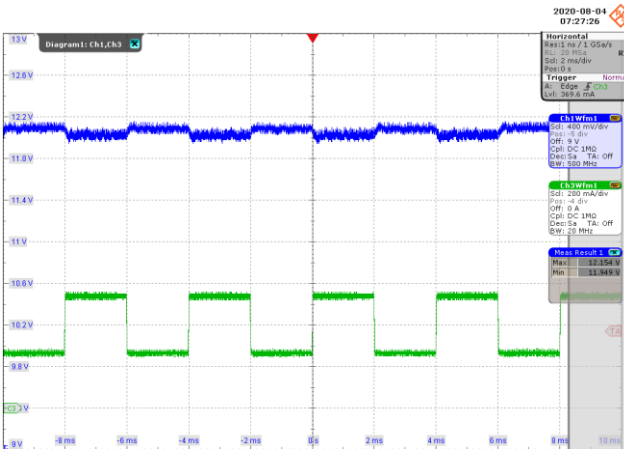

Figure 93 – Transient Output Waveforms.
 265 VAC.
 Upper: V_{OUT} , 400 mV / div., 2 ms / div.
 Lower: I_{OUT} 200 mA / div.
 Load Transient: 50 % - 100%.
 Duty Cycle, Slew Rate: 50%, 0.8 A / μ s.
 Frequency: 250 Hz.
 V_{MAX} : 12.15 V, V_{MIN} : 11.95 V.

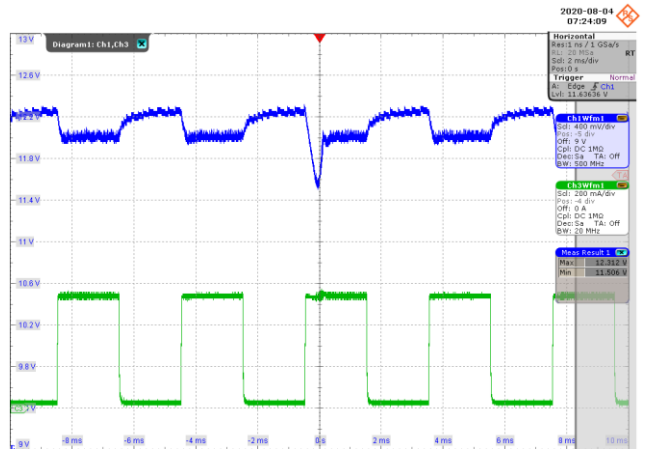

Figure 94 – Transient Output Waveforms.
 265 VAC.
 Upper: V_{OUT} , 400 mV / div., 2 ms / div.
 Lower: I_{OUT} 200 mA / div.
 Load Transient: 5 % - 100%.
 Duty Cycle, Slew Rate: 50%, 0.8 A / μ s.
 Frequency: 250 Hz.
 V_{MAX} : 12.31 V, V_{MIN} : 11.51 V.

11 Conducted EMI

11.1 550 mA Resistive Load, Floating Output (QPK / AV)

After running for 15 minutes.

11.1.1 115 VAC

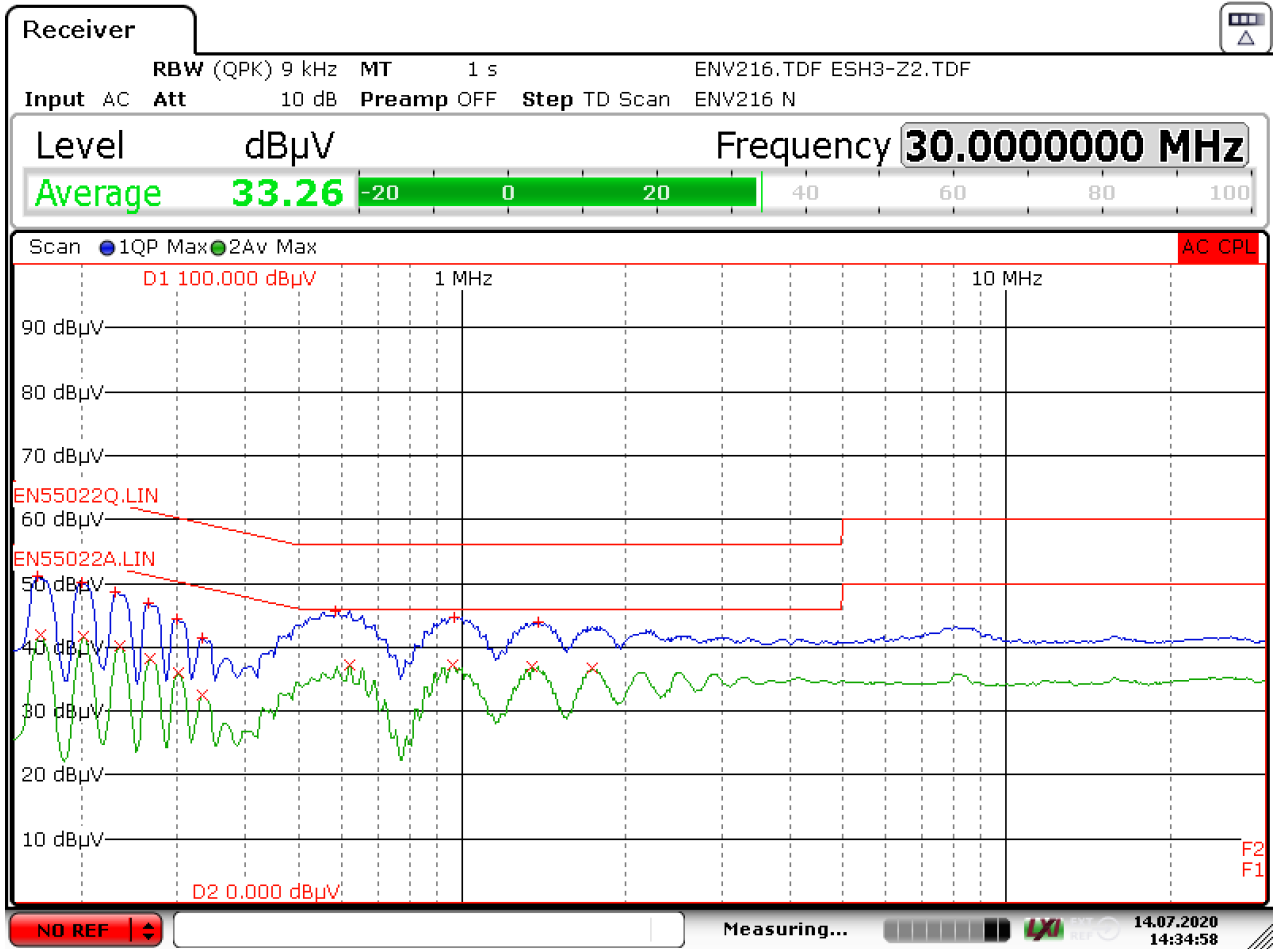

Date: 14.JUL.2020 14:34:59

Figure 95 – Floating Ground EMI at 115 VAC.



11.1.2 230 VAC

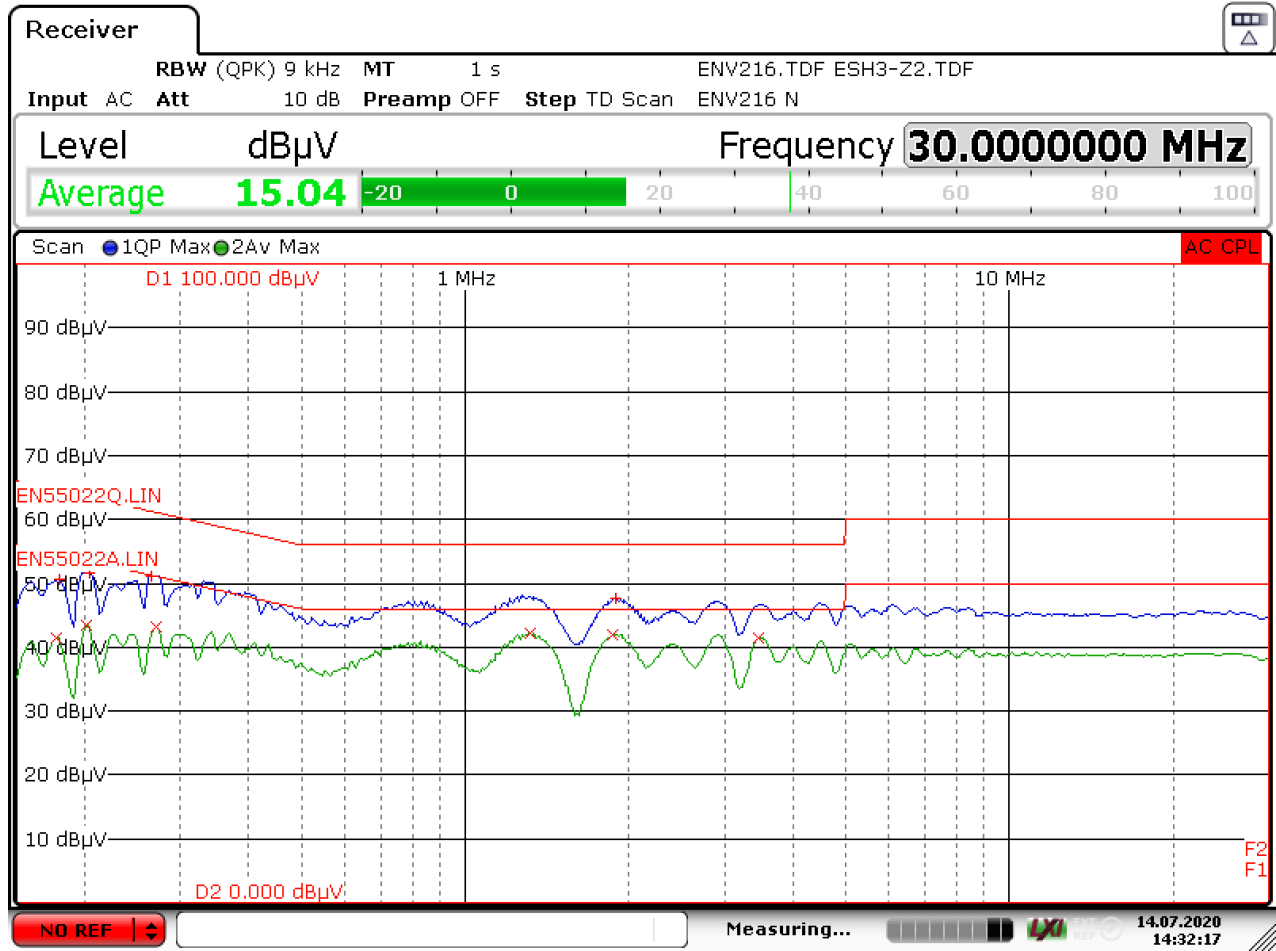

Date: 14.JUL.2020 14:32:17

Figure 96 – Floating Ground at 230 VAC.

12 Lightning Surge

12.1 Differential Mode Test

Passed ± 1 kV surge test.

Surge Voltage (kV)	Phase Angle	IEC Coupling	Generator Impedance (Ω)	Number Strikes	Result	Remarks
+1	0	L1/L2	2	10	PASS	No Auto-restart
-1	0	L1/L2	2	10	PASS	No Auto-restart
+1	90	L1/L2	2	10	PASS	No Auto-restart
-1	90	L1/L2	2	10	PASS	No Auto-restart
+1	180	L1/L2	2	10	PASS	No Auto-restart
-1	180	L1/L2	2	10	PASS	No Auto-restart
+1	270	L1/L2	2	10	PASS	No Auto-restart
-1	270	L1/L2	2	10	PASS	No Auto-restart

12.1.1 1000 V 90° Differential Mode Surge

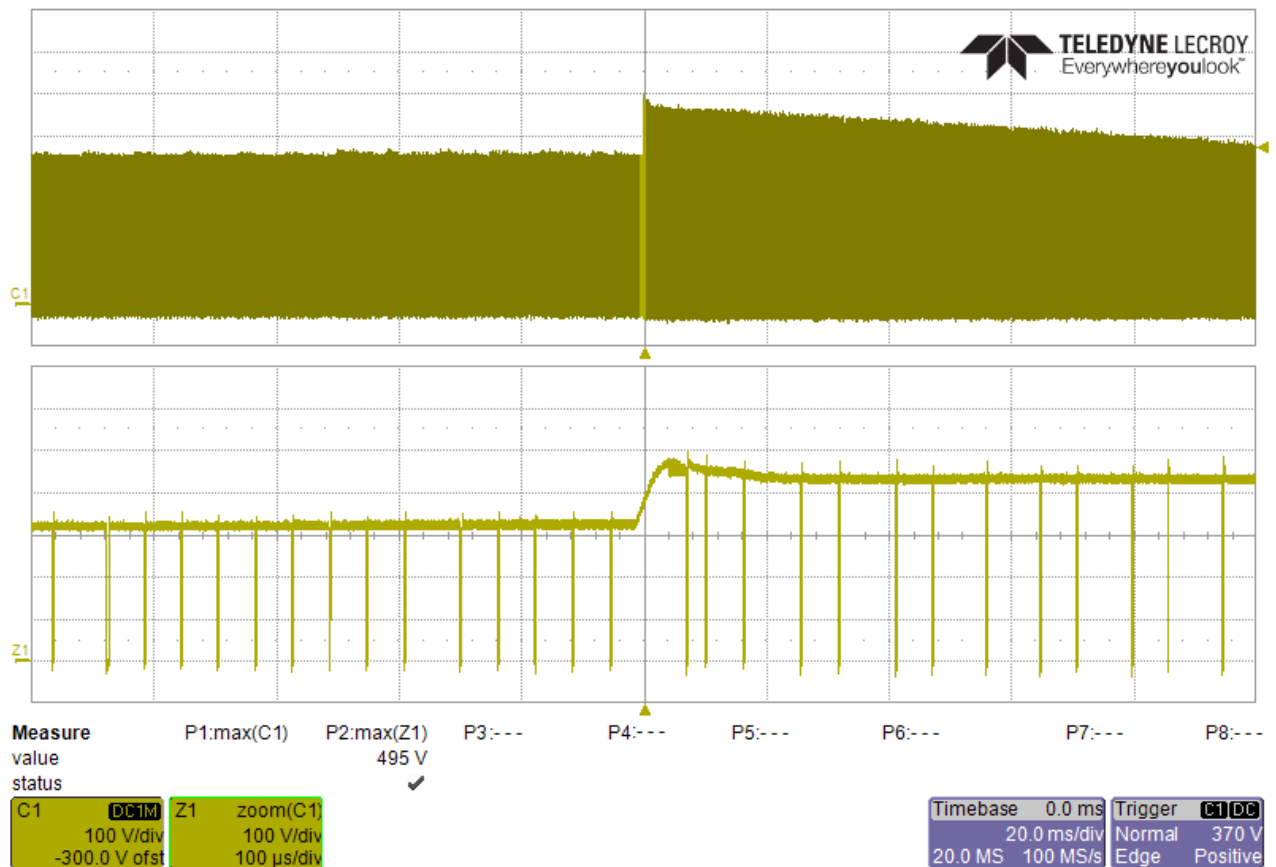

Figure 97 – Drain Voltage, 230 VAC, Full Load.

12.1.2 -1000 V 270° Differential Mode Surge

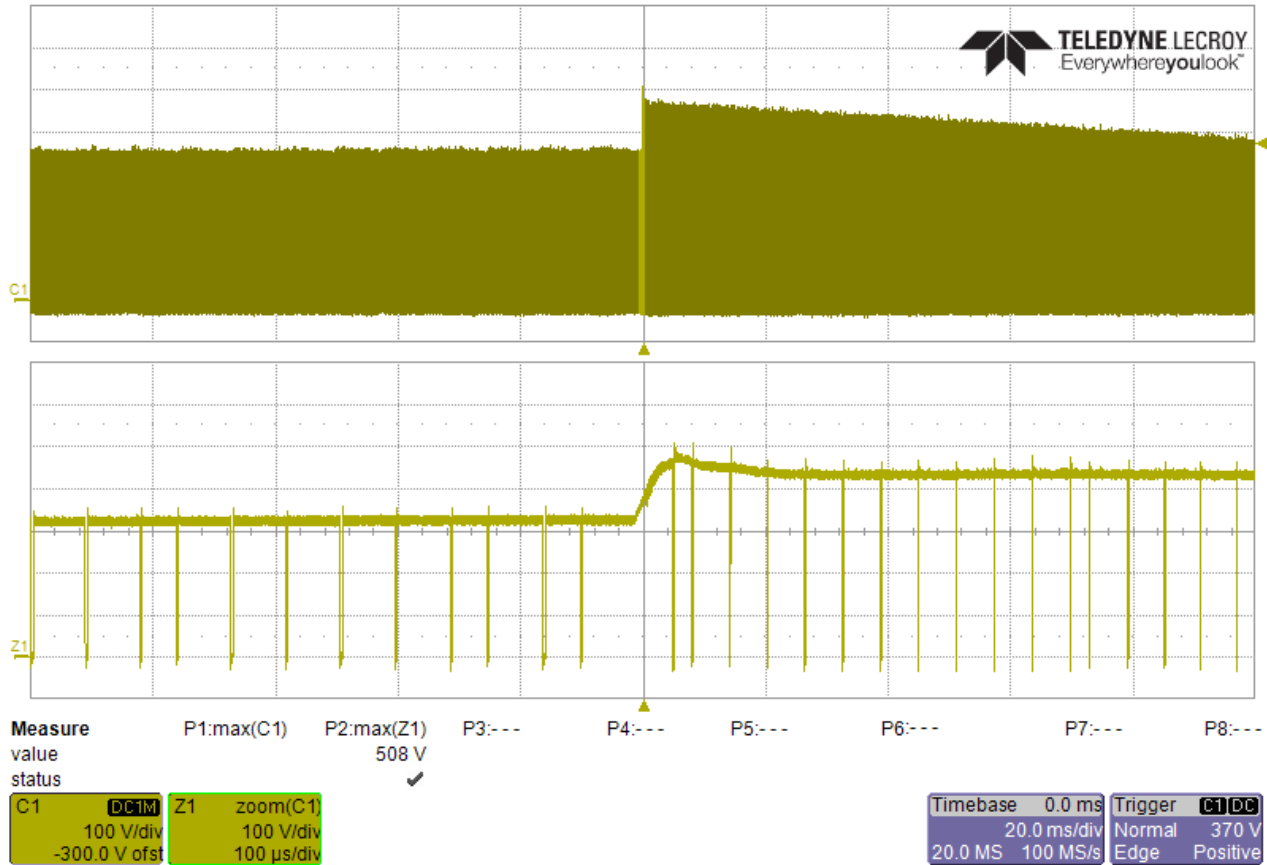

Figure 98 – Drain Voltage, 230 VAC, Full Load.

13 Revision History

Date	Author	Revision	Description & Changes	Reviewed
02-Sep-20	VRRA	1.0	Initial Release	Apps & Mktg
08-Oct-20	KM	1.1	Added C1, C2 Alternate Part.	Apps & Mktg



For the latest updates, visit our website: www.power.com

Reference Designs are technical proposals concerning how to use Power Integrations' gate drivers in particular applications and/or with certain power modules. These proposals are "as is" and are not subject to any qualification process. The suitability, implementation and qualification are the sole responsibility of the end user. The statements, technical information and recommendations contained herein are believed to be accurate as of the date hereof. All parameters, numbers, values and other technical data included in the technical information were calculated and determined to our best knowledge in accordance with the relevant technical norms (if any). They may base on assumptions or operational conditions that do not necessarily apply in general. We exclude any representation or warranty, express or implied, in relation to the accuracy or completeness of the statements, technical information and recommendations contained herein. No responsibility is accepted for the accuracy or sufficiency of any of the statements, technical information, recommendations or opinions communicated and any liability for any direct, indirect or consequential loss or damage suffered by any person arising therefrom is expressly disclaimed.

Power Integrations reserves the right to make changes to its products at any time to improve reliability or manufacturability. Power Integrations does not assume any liability arising from the use of any device or circuit described herein. POWER INTEGRATIONS MAKES NO WARRANTY HEREIN AND SPECIFICALLY DISCLAIMS ALL WARRANTIES INCLUDING, WITHOUT LIMITATION, THE IMPLIED WARRANTIES OF MERCHANTABILITY, FITNESS FOR A PARTICULAR PURPOSE, AND NON-INFRINGEMENT OF THIRD PARTY RIGHTS.

Patent Information

The products and applications illustrated herein (including transformer construction and circuits' external to the products) may be covered by one or more U.S. and foreign patents, or potentially by pending U.S. and foreign patent applications assigned to Power Integrations. A complete list of Power Integrations' patents may be found at www.power.com. Power Integrations grants its customers a license under certain patent rights as set forth at <http://www.power.com/ip.htm>.

Power Integrations, the Power Integrations logo, CAPZero, ChiPhy, CHY, DPA-Switch, EcoSmart, E-Shield, eSIP, eSOP, HiperPLC, HiperPFS, HiperTFS, InnoSwitch, Innovation in Power Conversion, InSOP, LinkSwitch, LinkZero, LYTSwitch, SENZero, TinySwitch, TOPSwitch, PI, PI Expert, SCALE, SCALE-1, SCALE-2, SCALE-3 and SCALE-iDriver, are trademarks of Power Integrations, Inc. Other trademarks are property of their respective companies. ©2019, Power Integrations, Inc.

Power Integrations Worldwide Sales Support Locations**WORLD HEADQUARTERS**

5245 Hellyer Avenue
San Jose, CA 95138, USA.
Main: +1-408-414-9200
Customer Service:
Worldwide: +1-65-635-64480
Americas: +1-408-414-9621
e-mail: usasales@power.com

CHINA (SHANGHAI)

Rm 2410, Charity Plaza, No. 88,
North Caoxi Road,
Shanghai, PRC 200030
Phone: +86-21-6354-6323
e-mail: chinasales@power.com

CHINA (SHENZHEN)

17/F, Hivac Building, No. 2, Keji
Nan 8th Road, Nanshan District,
Shenzhen, China, 518057
Phone: +86-755-8672-8689
e-mail: chinasales@power.com

GERMANY (AC-DC/LED Sales)

Einsteinring 24
85609 Dornach/Aschheim
Germany
Tel: +49-89-5527-39100
e-mail: eurosales@power.com

GERMANY (Gate Driver Sales)

HellwegForum 1
59469 Ense
Germany
Tel: +49-2938-64-39990
e-mail: igbt-driver.sales@power.com

INDIA

#1, 14th Main Road
Vasanthanagar
Bangalore-560052
India
Phone: +91-80-4113-8020
e-mail: indiasales@power.com

ITALY

Via Milanese 20, 3rd. Fl.
20099 Sesto San Giovanni (MI) Italy
Phone: +39-024-550-8701
e-mail: eurosales@power.com

JAPAN

Yusen Shin-Yokohama 1-chome Bldg.
1-7-9, Shin-Yokohama, Kohoku-ku
Yokohama-shi,
Kanagawa 222-0033 Japan
Phone: +81-45-471-1021
e-mail: japansales@power.com

KOREA

RM 602, 6FL
Korea City Air Terminal B/D,
159-6
Samsung-Dong, Kangnam-Gu,
Seoul, 135-728 Korea
Phone: +82-2-2016-6610
e-mail: koreasales@power.com

SINGAPORE

51 Newton Road,
#19-01/05 Goldhill Plaza
Singapore, 308900
Phone: +65-6358-2160
e-mail: singaporesales@power.com

TAIWAN

5F, No. 318, Nei Hu Rd.,
Sec. 1
Nei Hu District
Taipei 11493, Taiwan R.O.C.
Phone: +886-2-2659-4570
e-mail: taiwansales@power.com

UK

Building 5, Suite 21
The Westbrook Centre
Milton Road
Cambridge
CB4 1YG
Phone: +44 (0) 7823-557484
e-mail: eurosales@power.com

